

Neutron spectroscopy

Andrew Wildes
Institut Laue-Langevin

Plan:

- Properties of the neutron
- Neutron spectroscopy
- Harmonic oscillators
- Atomic vibrations
 - Quantized energy levels
 - Tunnelling
- Magnetic vibrations
 - Crystal fields
 - Molecular magnets
- Propagating modes
 - Phonons
 - Magnons

The neutron

Forms part of the nucleus of the atom

Rest mass (m_n)	$1.675 \times 10^{-27} \text{ kg}$ (c.f. mass of hydrogen = $1.674 \times 10^{-27} \text{ kg}$)
Diameter	$\sim 10^{-15} \text{ m}$ (c.f. diameter of an atom $\sim 10^{-10} \text{ m}$)
Charge	0
Spin	-1/2
Magnetic moment	$0.966 \times 10^{-26} \text{ JT}^{-1}$ $-1.913 \mu_N = -\gamma \mu_N$ $1.042 \times 10^{-3} \mu_B$ (c.f. moment on an electron = $1 \mu_B$)

Neutron beams

Through quantum mechanics, neutrons have a *wavelength*.

Energy of a neutron

$$E = h\nu = \hbar\omega$$

h = Planck's constant

ν = frequency

ω = angular frequency

v = speed

$$= \frac{1}{2} m_n v^2$$

Momentum of a neutron

$$p = h/\lambda = \hbar k$$

λ = wavelength

k = wavenumber

$$\mathbf{p} = \hbar \mathbf{k}$$

‘Standard’ thermal neutrons:

$$v = 2200 \text{ m/s}$$

$$\lambda = 1.798 \text{ \AA}$$

$$T = 293 \text{ K}$$

$$E = 25.3 \text{ meV} = 6 \text{ THz}$$

$$p = 3.68 \times 10^{-24} \text{ kg m s}^{-1} = 3.5 \text{ \AA}^{-1}$$

Neutron scattering – length and time scales

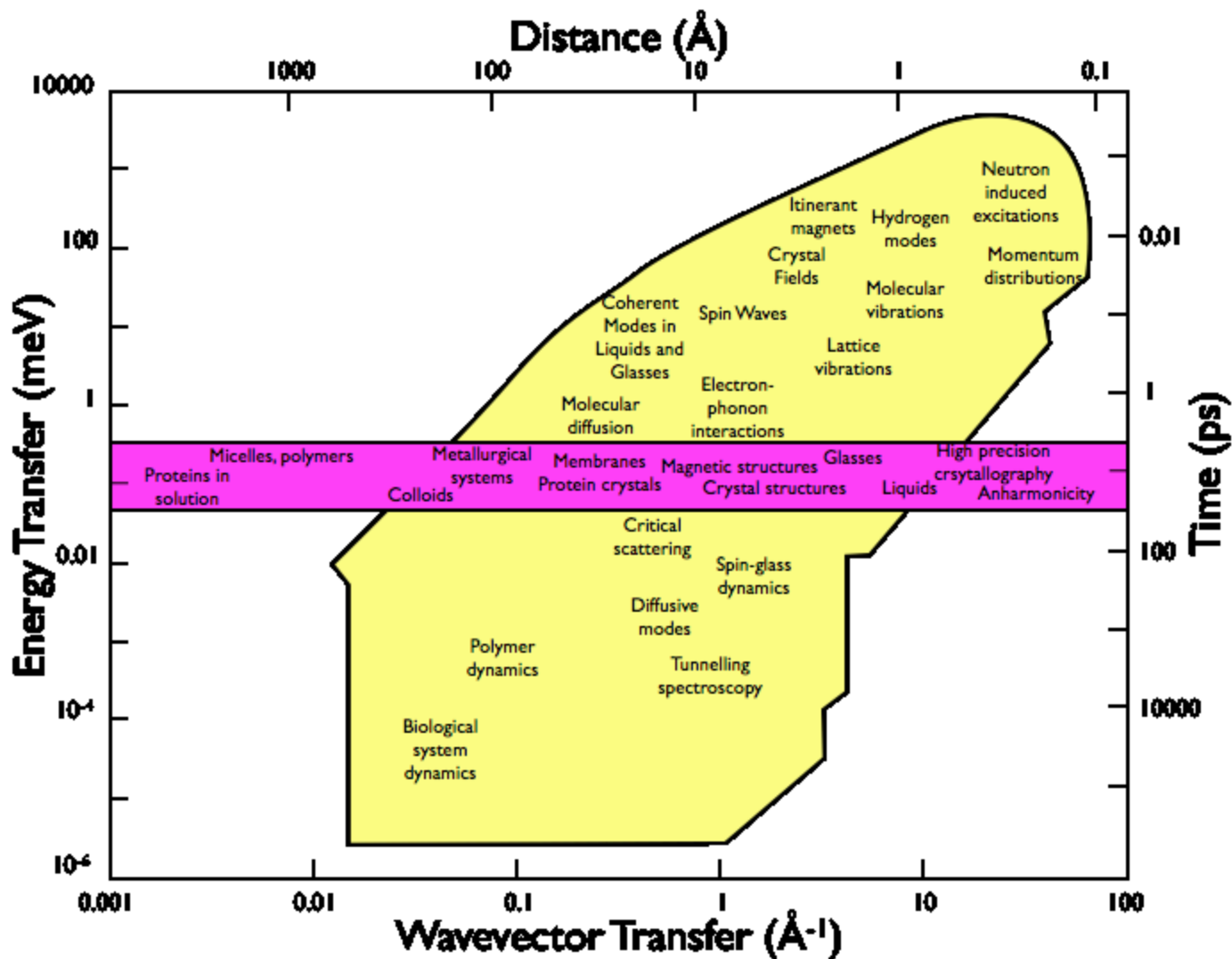

A neutron scattering experiment

Fig. 1.2 Geometry for scattering experiment.

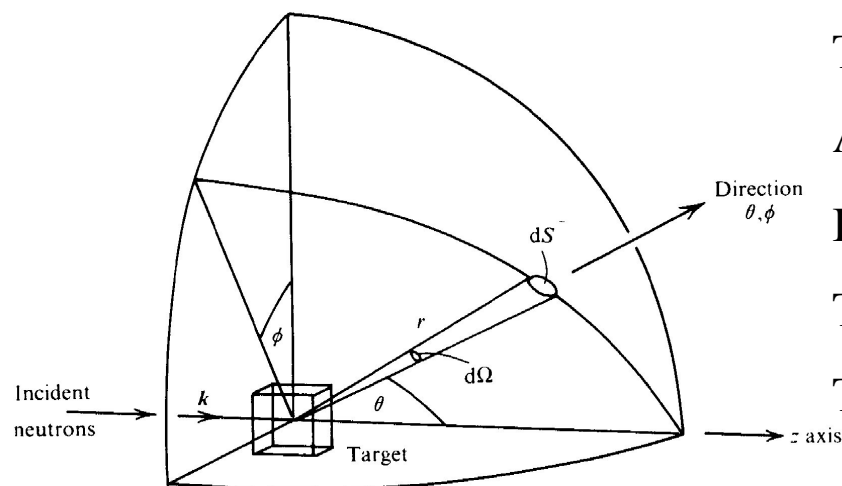

The target volume is initially in state ζ .

A neutron enters with wave vector k and spin s

It interacts with the target.

The final neutron wave vector is k' and spin s' .

The final target state is ζ' .

We measure:

Momentum transfer: $\mathbf{Q} = k' - k$

$$Q^2 = k^2 + k'^2 - 2kk' \sin\Theta$$

Energy transfer: $\Delta E = \hbar\omega = \frac{\hbar}{2m_n} (k^2 - k'^2)$

A neutron scattering experiment

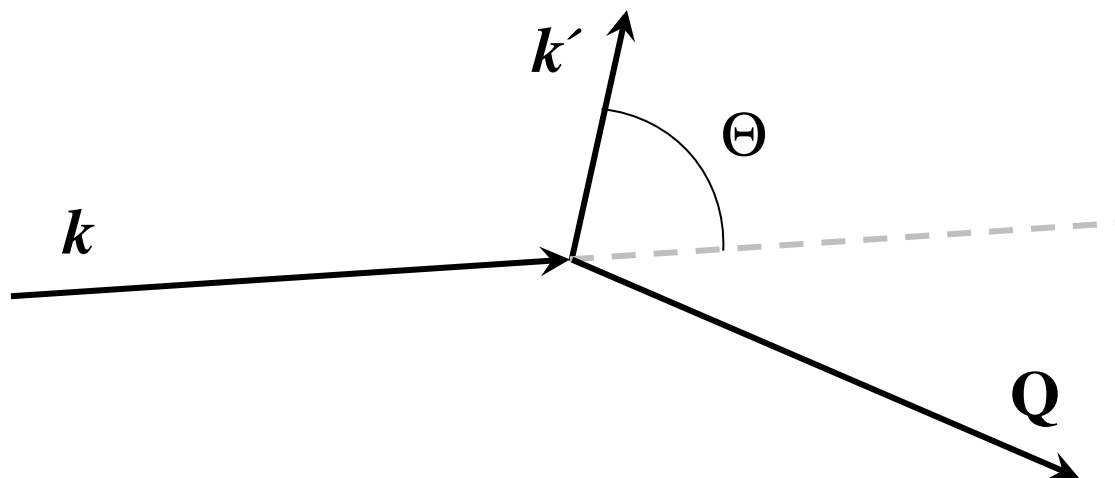

We measure:

Momentum transfer: $\mathbf{Q} = \mathbf{k}' - \mathbf{k}$

$$Q^2 = k^2 + k'^2 - 2kk' \sin\Theta$$

Energy transfer: $\Delta E = \hbar\omega = \frac{\hbar^2}{2m_n} (k^2 - k'^2)$

Knowing the neutron wavelength

You must know the wavelength to perform a scattering experiment

With neutrons, there are two ways of knowing the wavelength:

1. Use a monochromator
 - Bragg's law: $2d\sin\theta = \lambda$
2. Use time-of-flight
 - Neutron speed $\propto 1/\lambda$, $4\text{\AA} \sim 1000 \text{ m/s}$
 - *chopper* to use *time-of-flight*

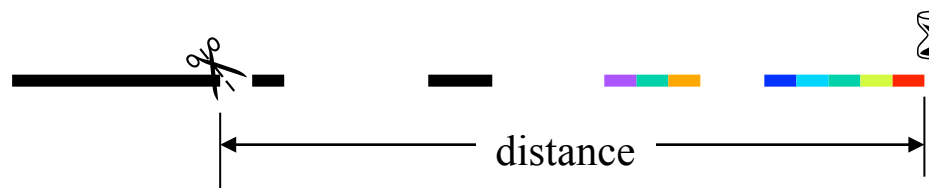

- *velocity selector* to monochromate

The neutron spin precession can also give energy change information

Classical harmonic oscillators

Pendulum

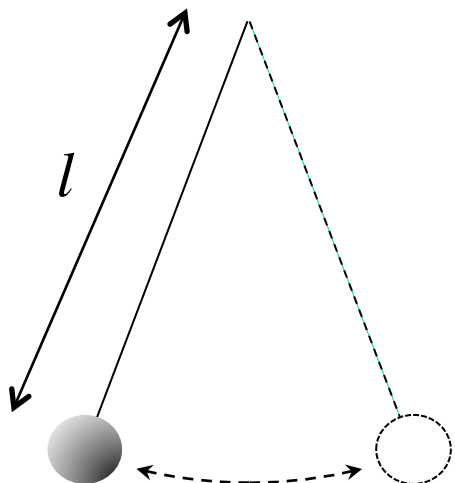

$$v = \frac{1}{2\pi} \sqrt{\frac{g}{l}}, \quad \omega = \sqrt{\frac{g}{l}}$$

Potential well

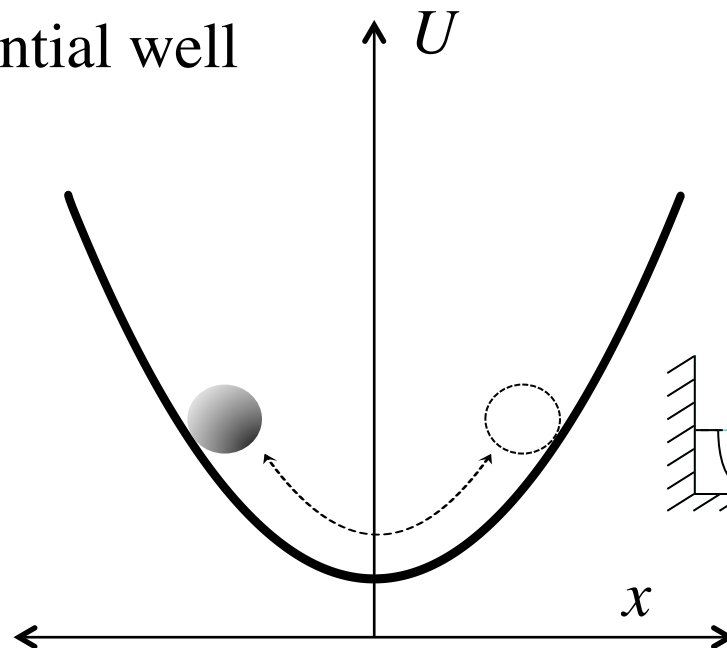

$$U = Ax^2$$

$$v = \frac{1}{2\pi} \sqrt{2Ag}, \quad \omega = \sqrt{2Ag}$$

Spring (constant = C)

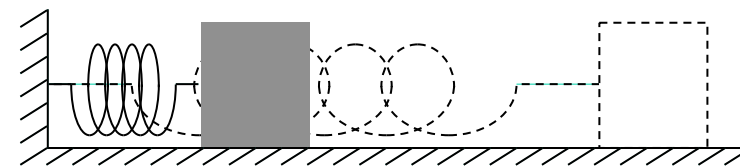

$$v = \frac{1}{2\pi} \sqrt{\frac{C}{m}}, \quad \omega = \sqrt{\frac{C}{m}}$$

Quantum harmonic oscillators

$$H\psi = E\psi$$

$$-\frac{\hbar^2}{2m} \frac{d^2\psi}{dx^2} + U(x)\psi = E\psi$$

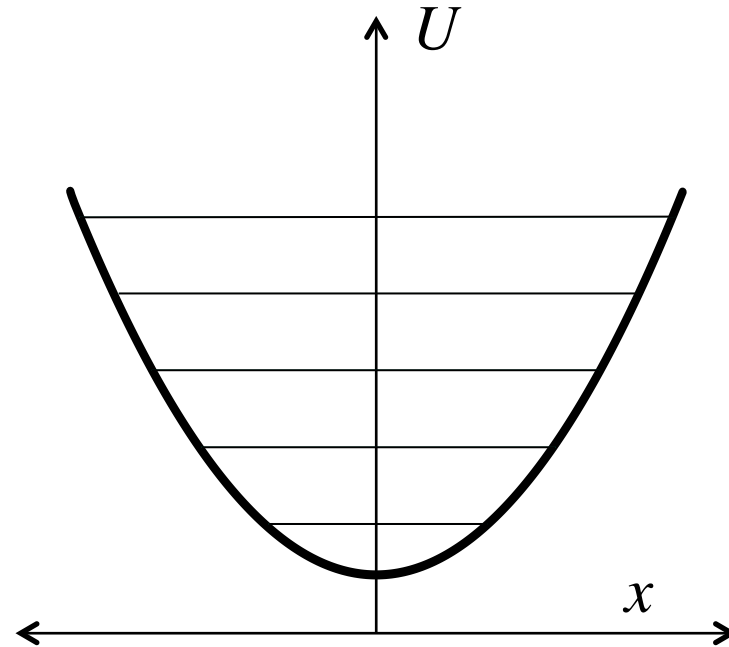

$$U = \frac{1}{2} m\omega^2 x^2$$

$$E = \hbar\omega \left(n + \frac{1}{2} \right)$$

Nitrogen motion in UN

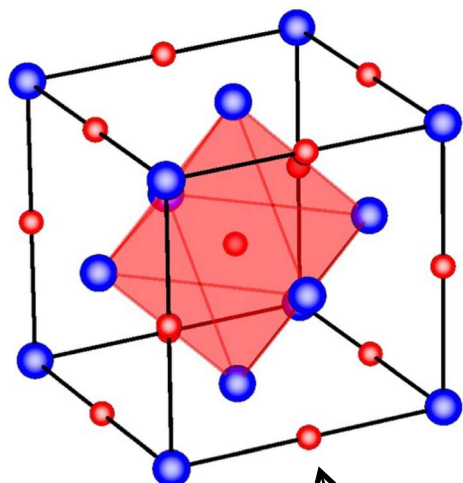

U (mass = 238)

N (mass = 14)

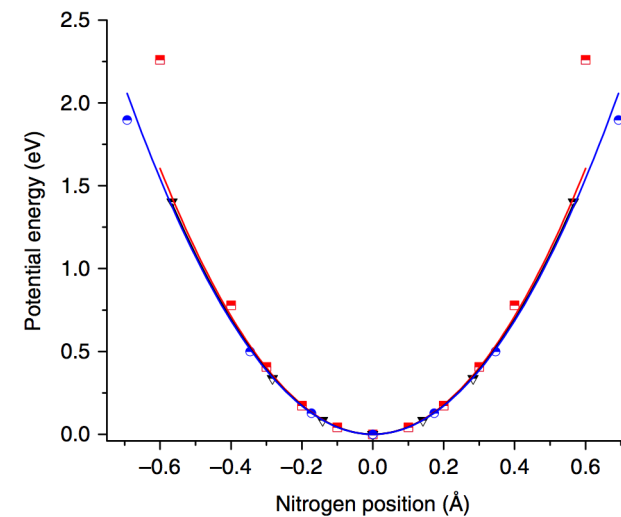
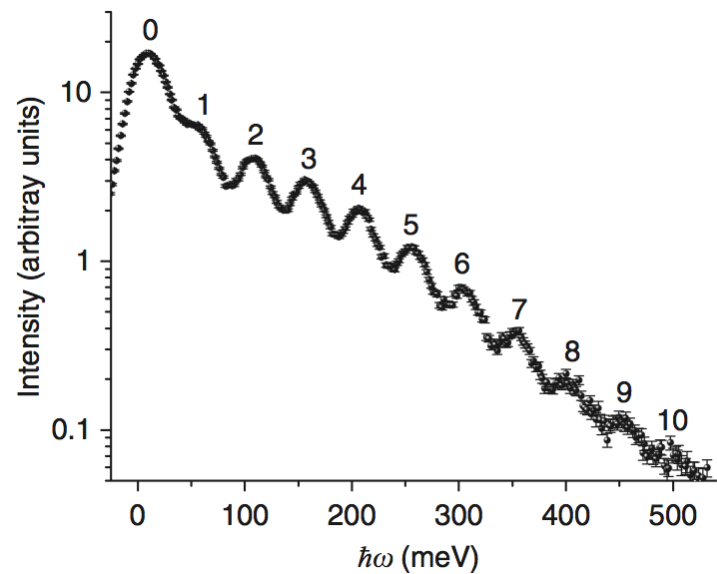

A. A. Aczel *et al.*, Nat. Comm. **3** (2012) 1124

Endohedral fullerene

“Molecular surgery”

$H_2, D_2, HD @C_{60}$

$H_2O @C_{60}$

$H_2, (H_2)_2 @C_{70}$

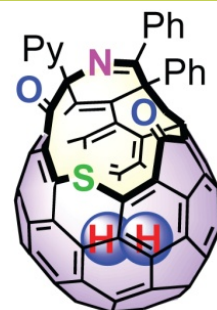

$H_2@ATOCF$



$H_2@C_{60}$



$HD@C_{60}$

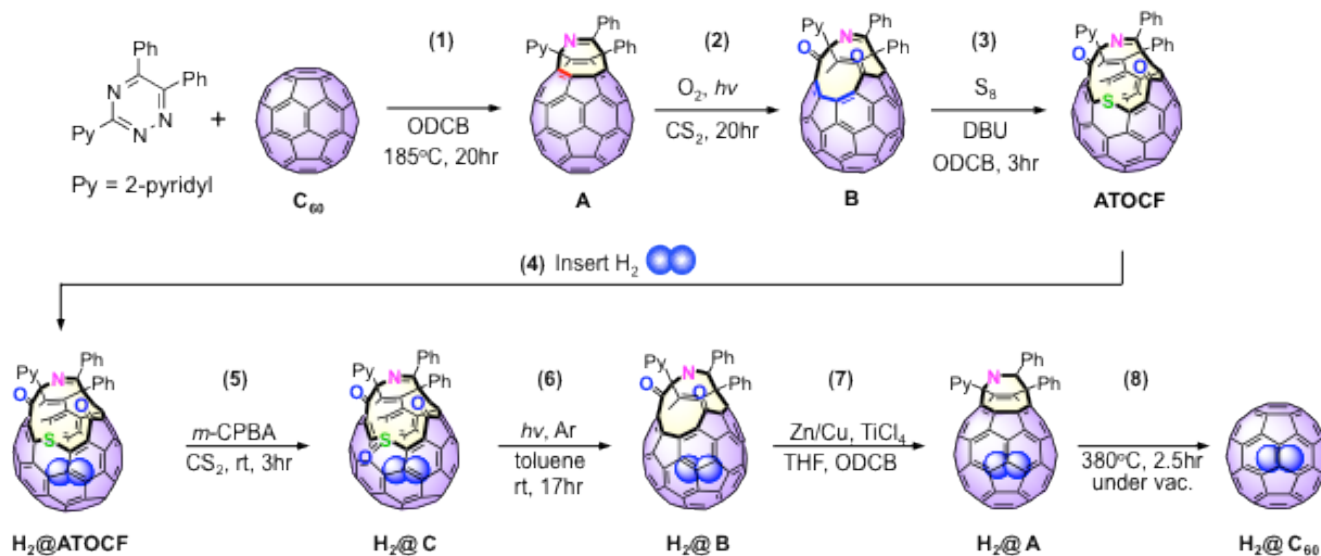

K.Komatsu, M.Murata and Y.Murata, Science 307, 238 (2005)

Endohedral fullerene

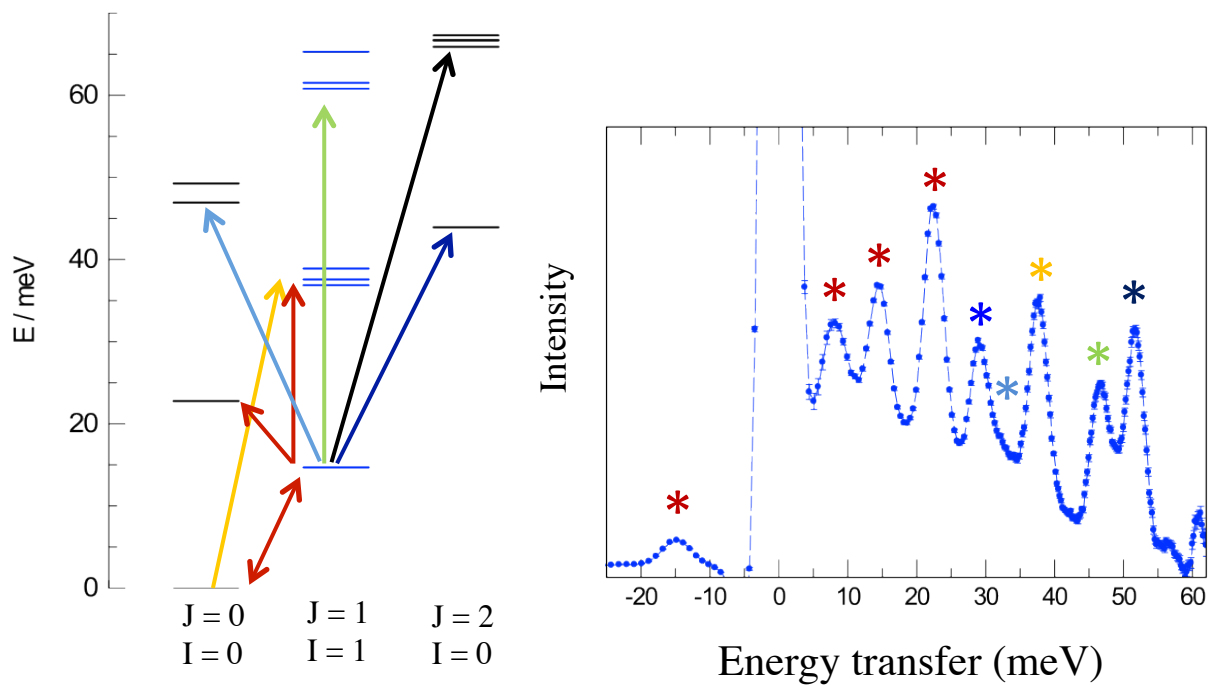

A. J. Horsewill *et al.*, Proc. Trans. Roy. Soc A **371** (2013) 20110627

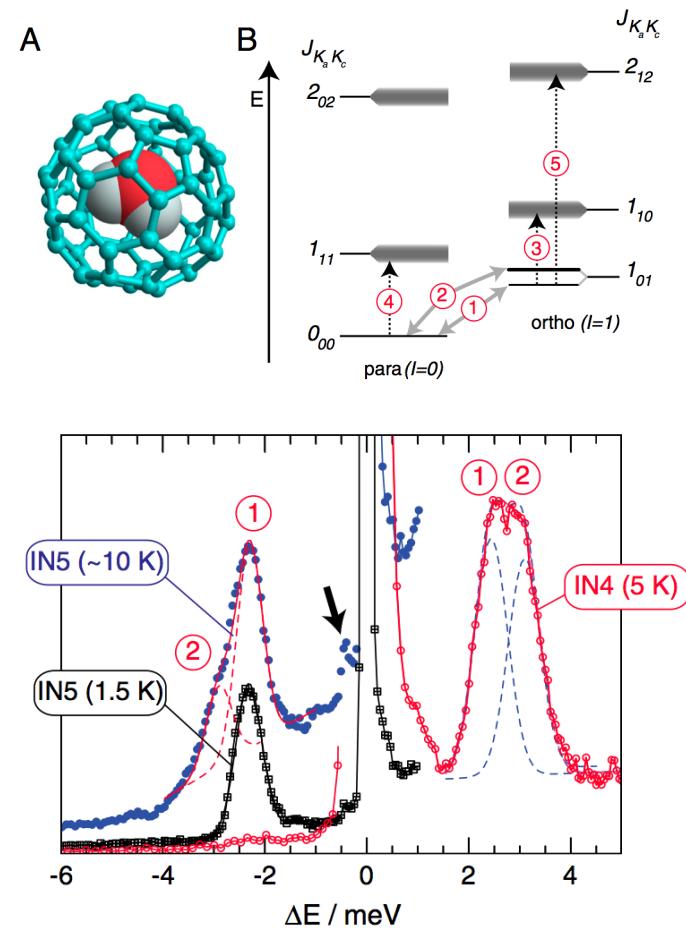

C. Beduz *et al.*, PNAS **109** (2012) 12894

Methyl group motion

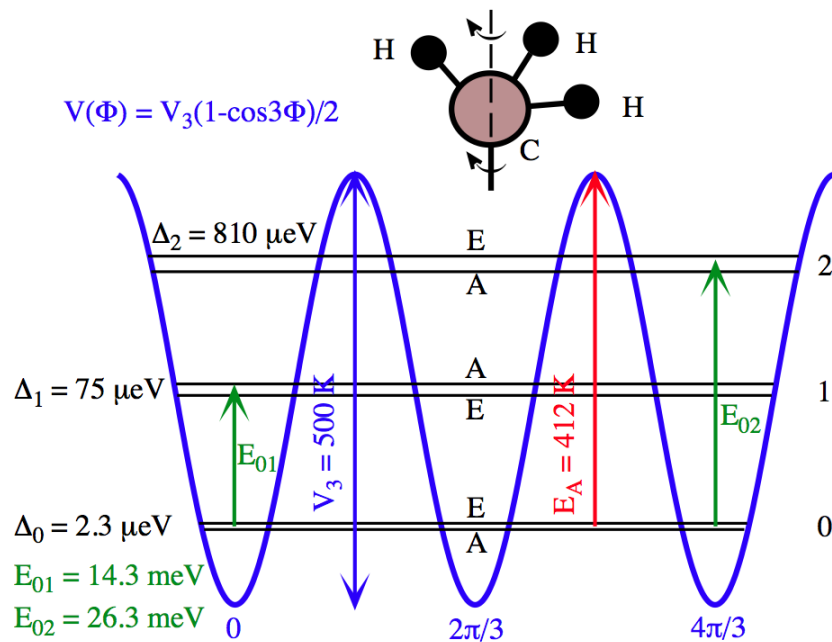

Tunnelling in Sodium Acetate Trihydrate

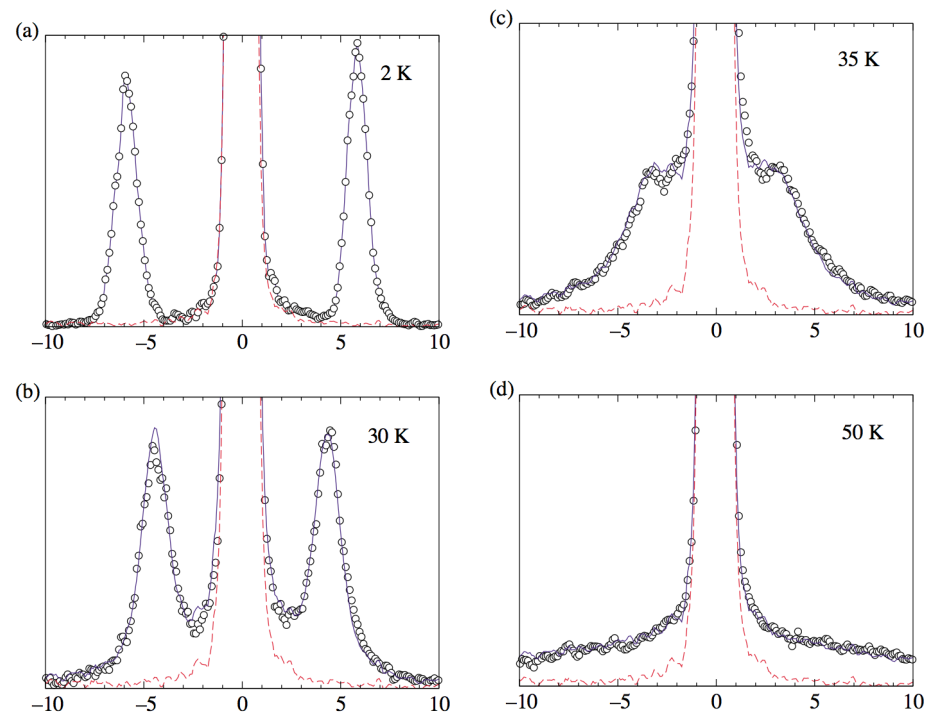

Energy transfer (μeV)

J. Colmenero *et al.*, Prog. Polym. Sci. **30** (2005) 1147

Tunnelling in (2,6)lutidine

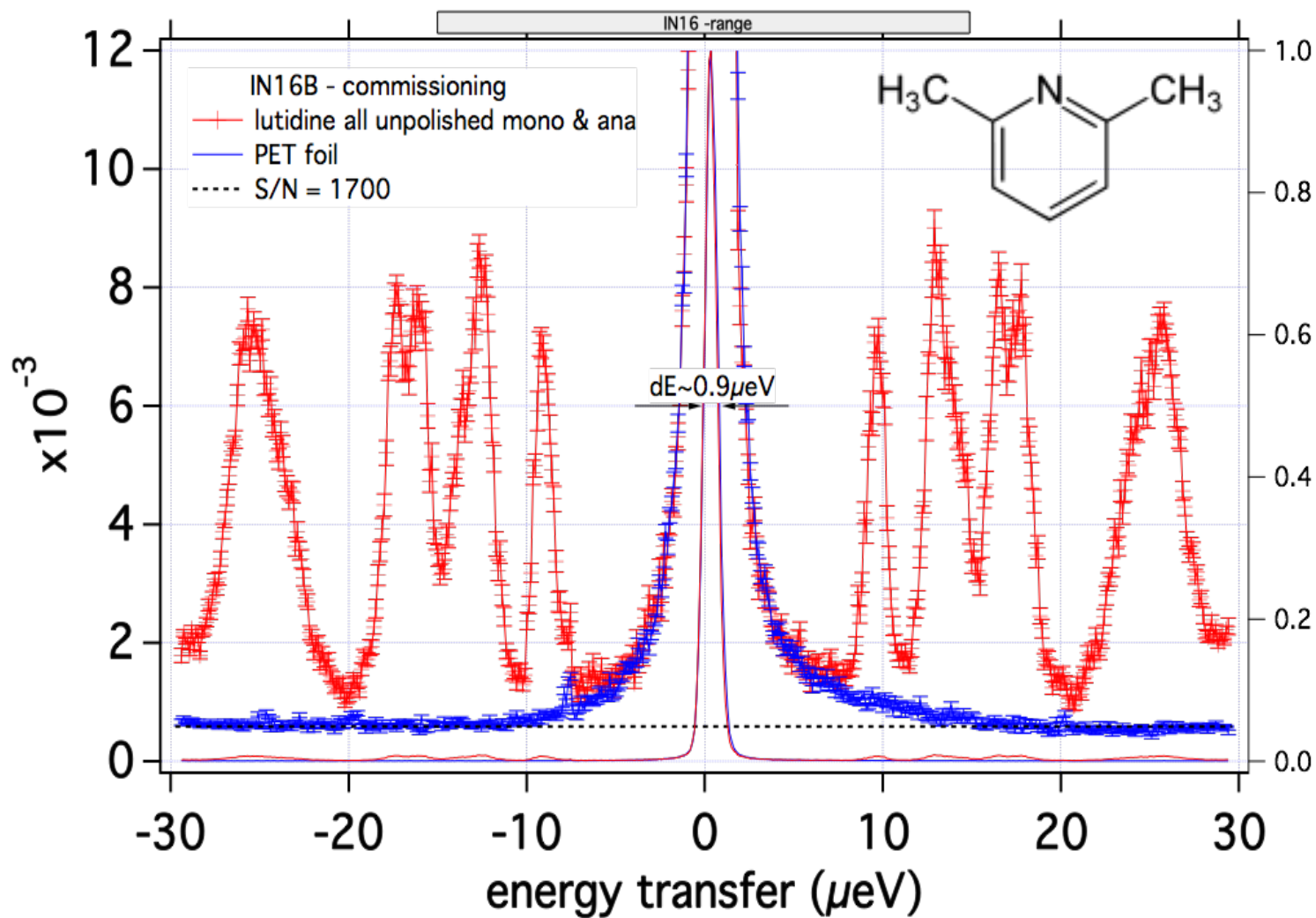

With thanks to B. Frick

Magnetism is caused by unpaired electrons or movement of charge.

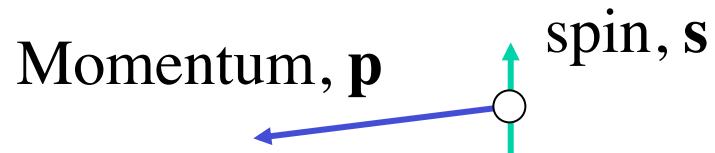

Magnetic spectroscopy requires a change of neutron *energy* and *angular momentum* (i.e. the neutron spin changes direction)

Magnetism can be classified as *localized* (i.e. confined to an atomic position) or *itinerant* (i.e. due to electrons that are moving through the sample)

We'll only discuss localized magnetism today.

Crystal field levels

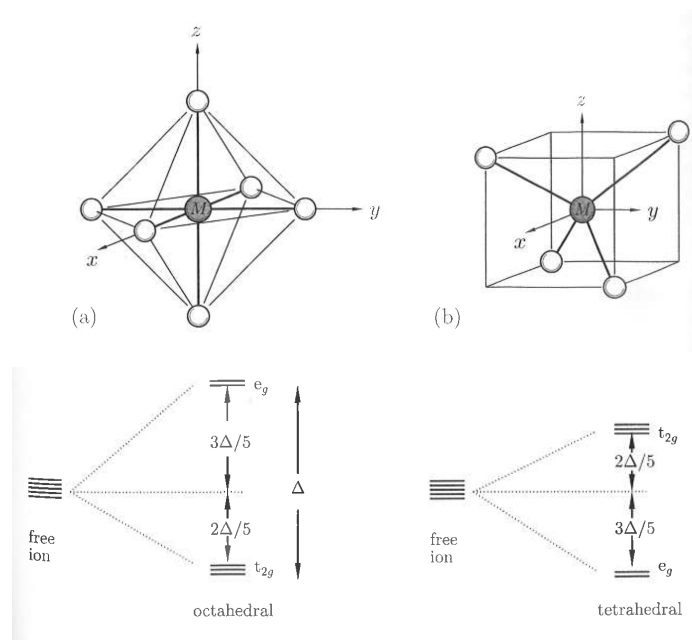
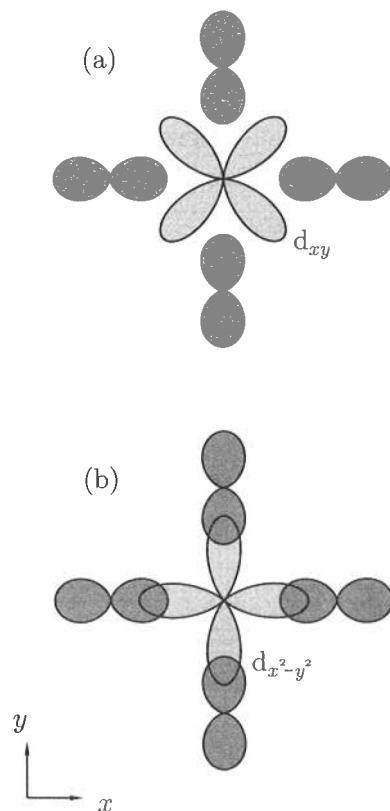
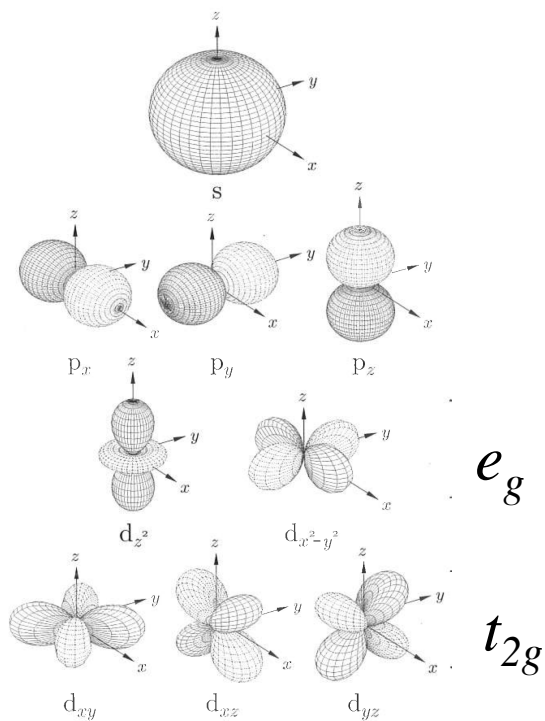

S. Blundell, *Magnetism in Condensed Matter* (2006) OUP (Oxford)

Crystal fields in NdPd_2Al_3

$$H = \sum_{l=2,4,6} B_l^0 O_l^0 + \sum_{l=2,4} B_l^4 O_l^4$$

O = Stevens parameters
(K. W. Stevens, Proc. Phys. Soc A65 (1952) 209)

B = CF parameters,
measured by neutrons

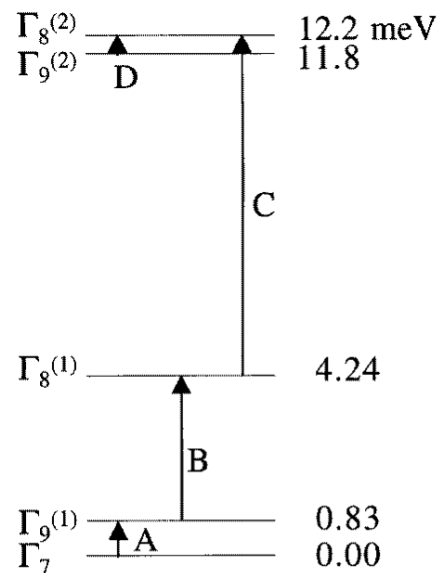
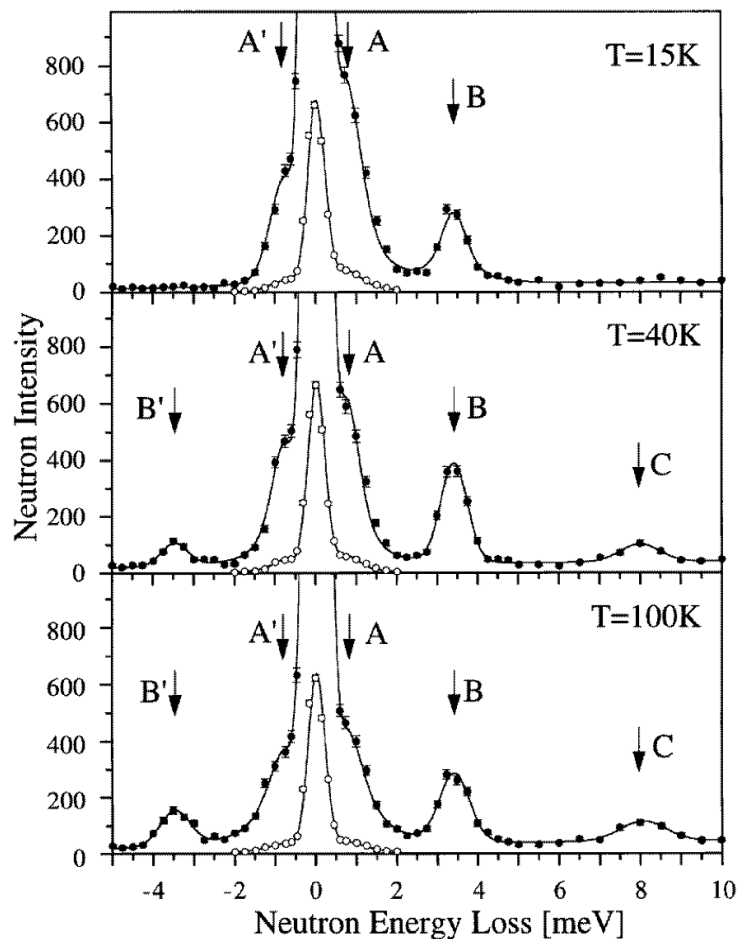

A. Dönni *et al.*, J. Phys.: Condens. Matter **9** (1997) 5921

O. Moze., *Handbook of magnetic materials* vol. 11, 1998 Elsevier, Amsterdam, p.493

Molecular magnets

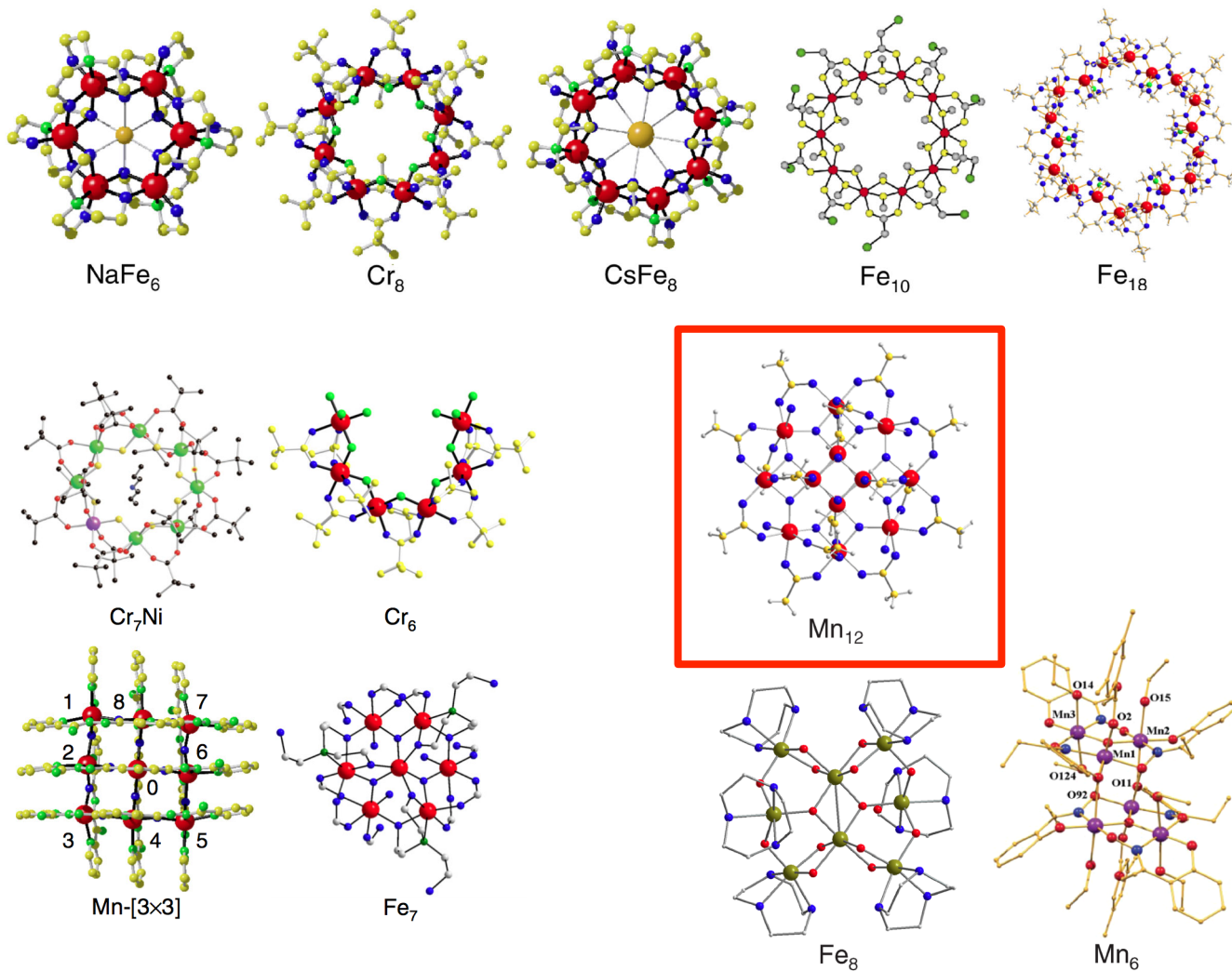

A. Furrer and O. Waldmann, *Rev. Mod. Phys.* **85** (2013) 367

Quantum tunneling in Mn₁₂-acetate

$$H = \sum_{l=2,4,6} B_l^0 O_l^0 + \sum_{l=2,4} B_l^4 O_l^4$$

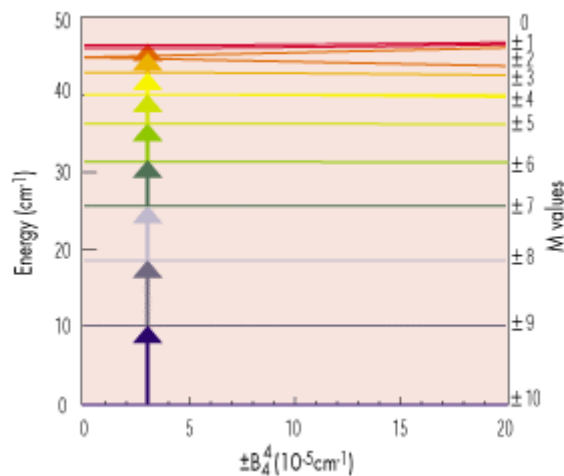

Calculated energy terms

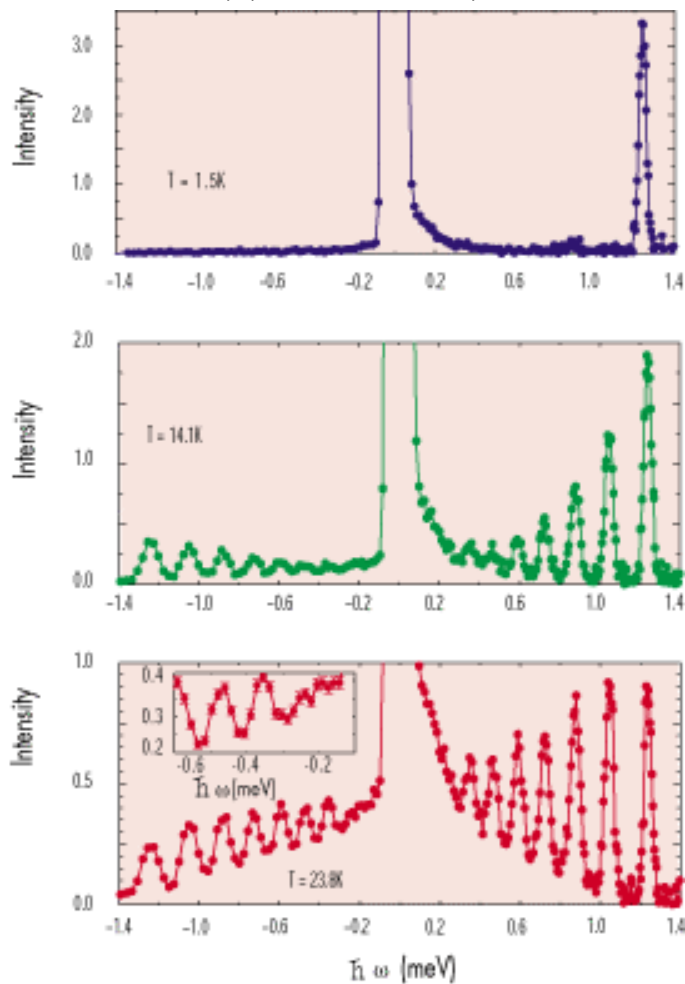

Neutron spectra

INSTITUT MAX VON LAUE - PAUL LANGEVIN

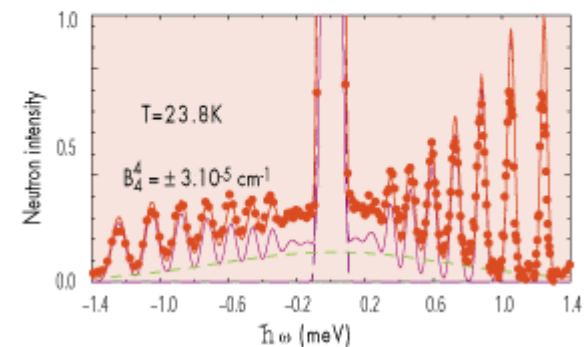

Fitted data with scattering from:

- energy levels
- elastic scattering
- incoherent background

I. Mirebeau *et al.*, Phys. Rev. Lett. **83** (1999) 628

R. Bircher *et al.*, Phys. Rev. B **70** (2004) 212413

Propagating lattice vibrations

Take a line of equal masses, M , joined by springs

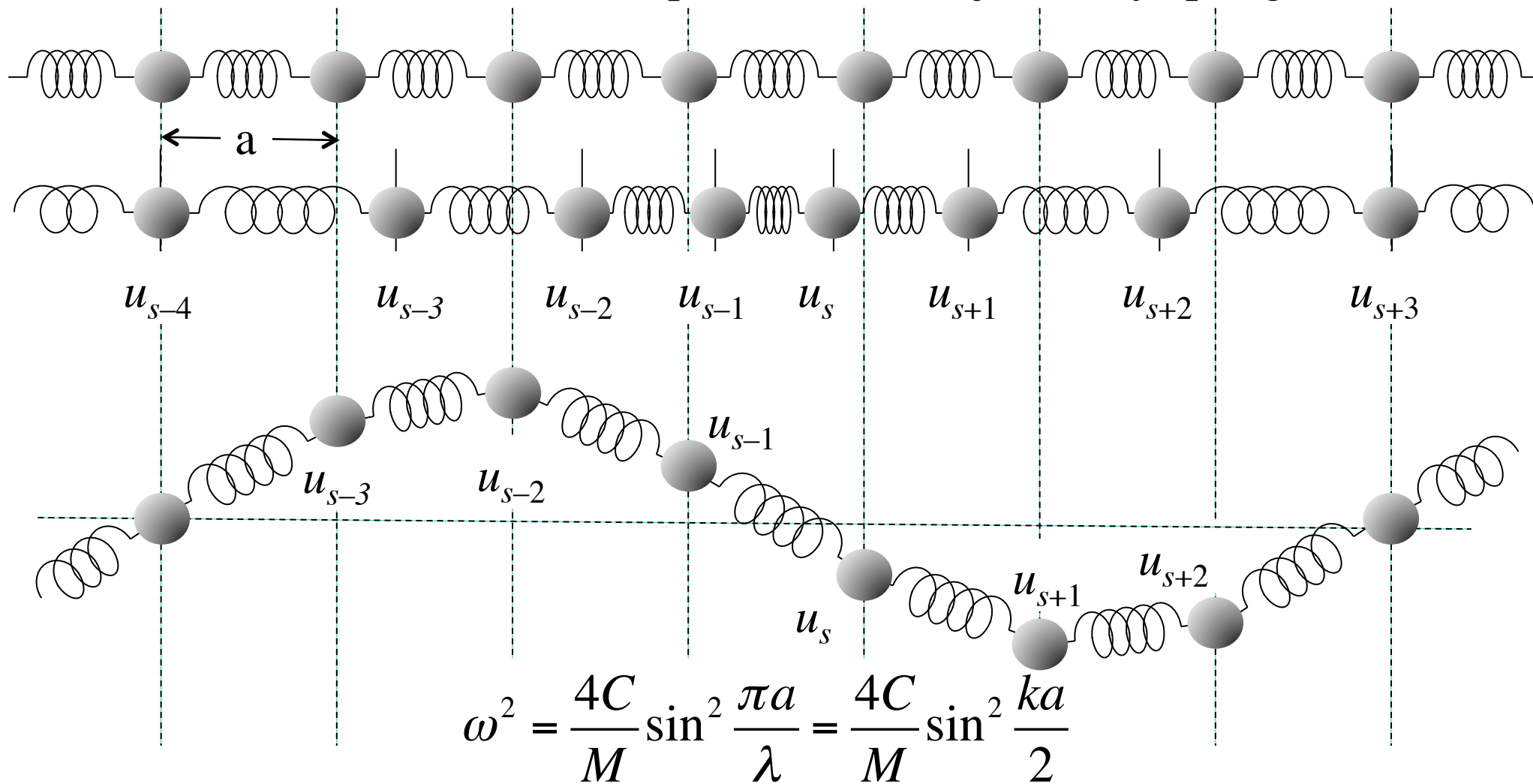

C. Kittel, *Introduction to Solid State Physics* (1996) Wiley, New York

Phonon dispersion

$$\omega^2 = \frac{4C}{M} \sin^2 \frac{\pi a}{\lambda} = \frac{4C}{M} \sin^2 \frac{ka}{2}$$

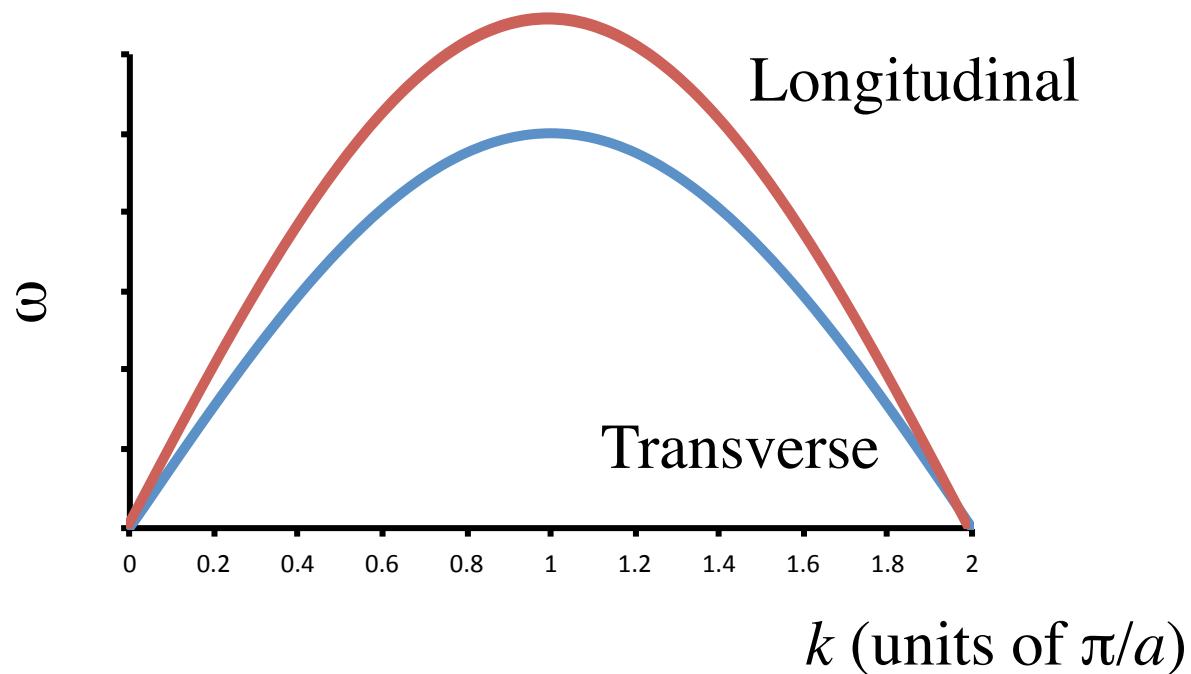

C. Kittel, *Introduction to Solid State Physics* (1996) Wiley, New York

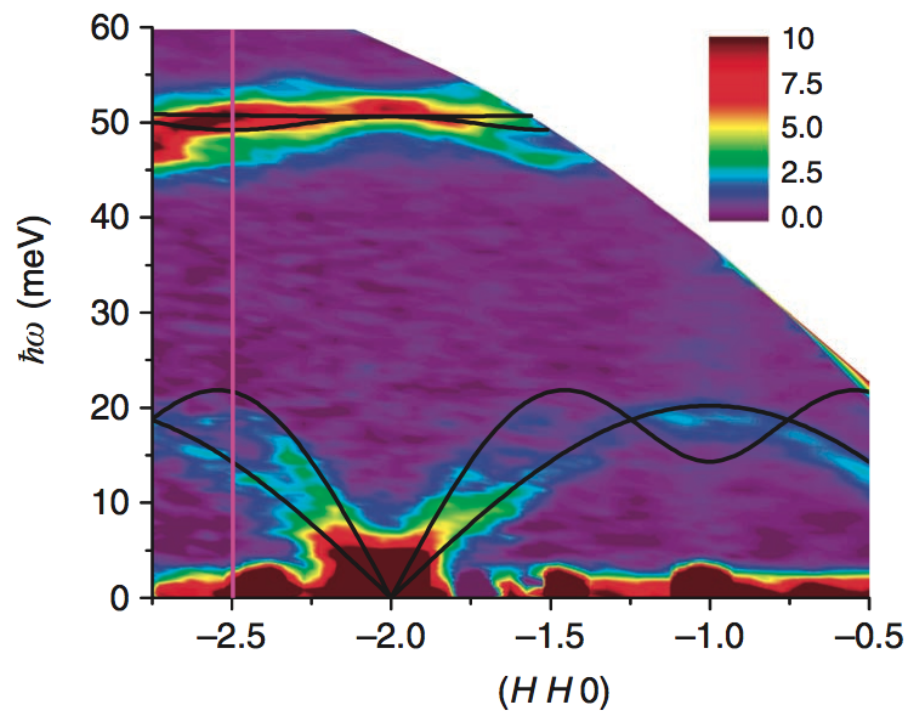
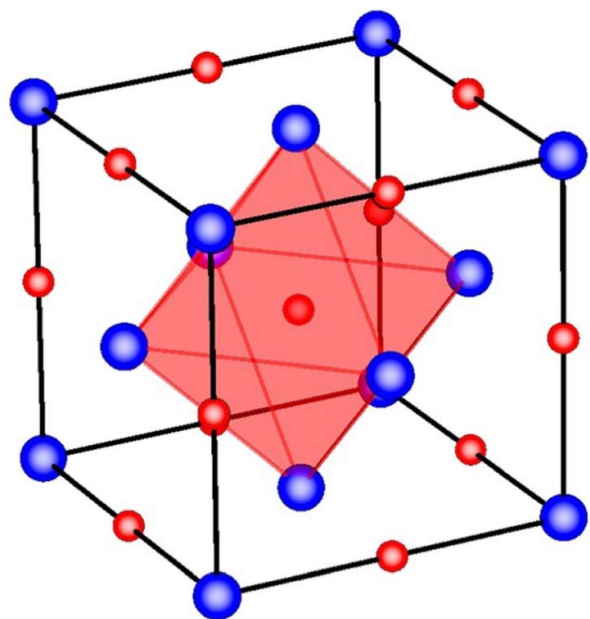

A. A. Aczel *et al.*, Nat. Comm. **3** (2012) 1124

Phonons in Diamond

DISPERSION CURVES FOR DIAMOND AT 296 °K

1000
meV

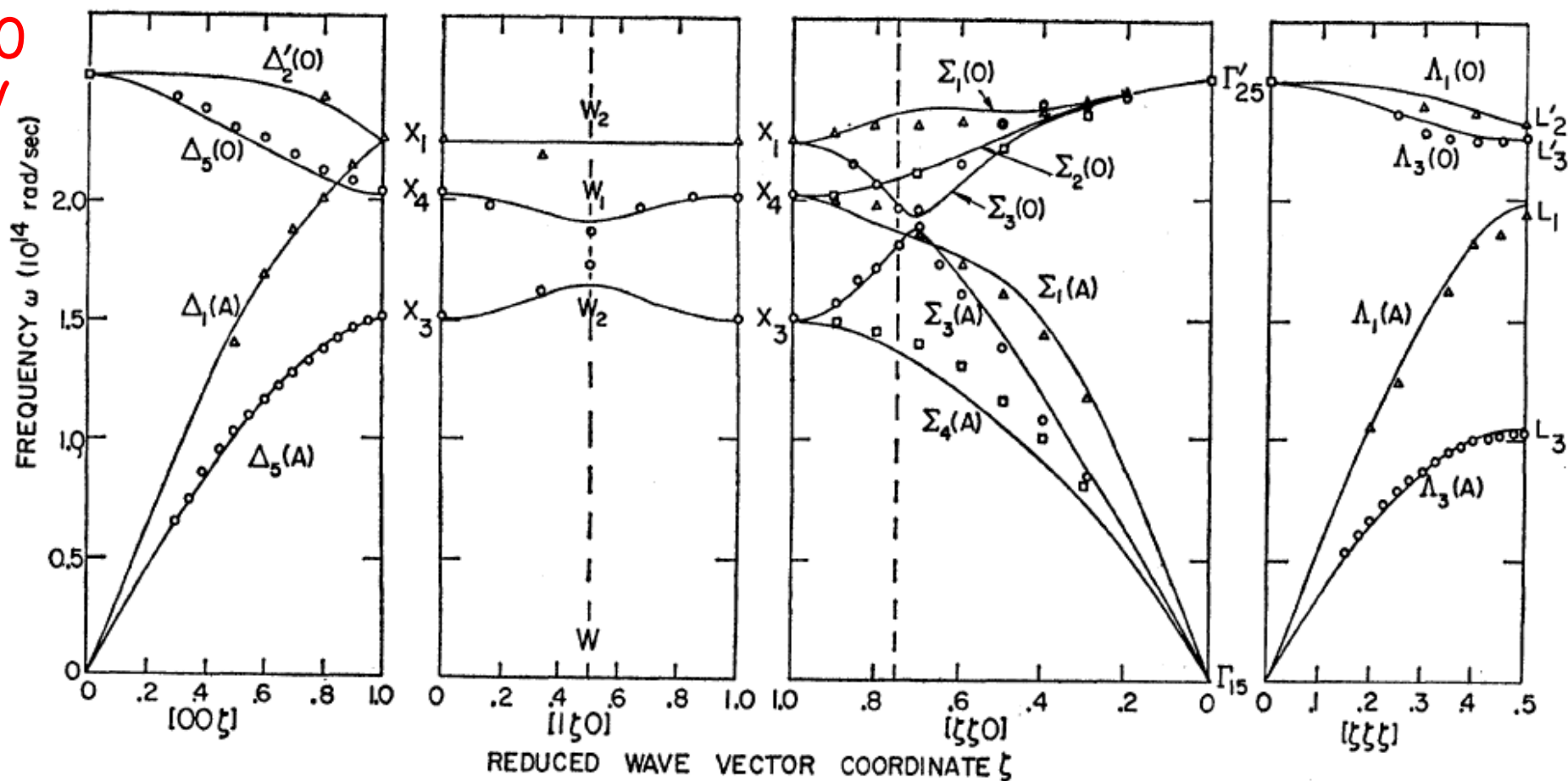

J.L. Warren et al. (1967) Phys.Rev. 158, 805

Phonons in fibre DNA

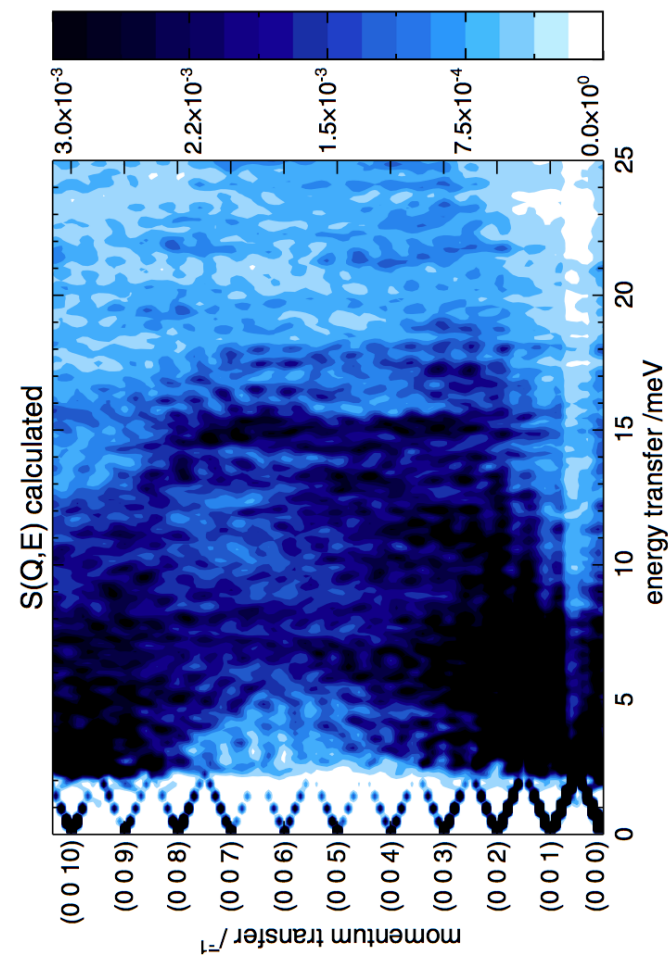
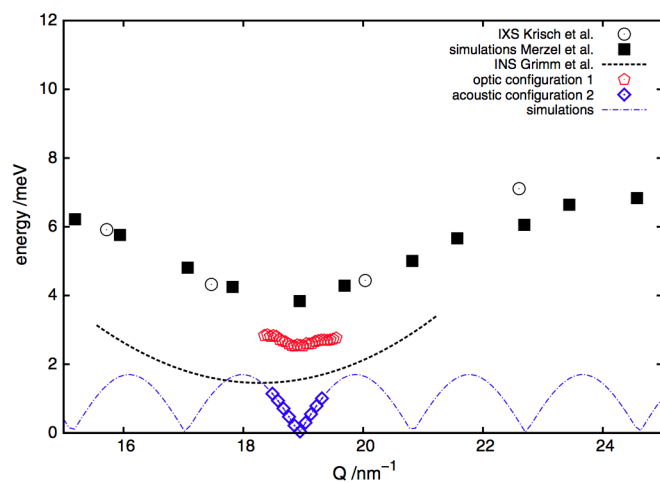
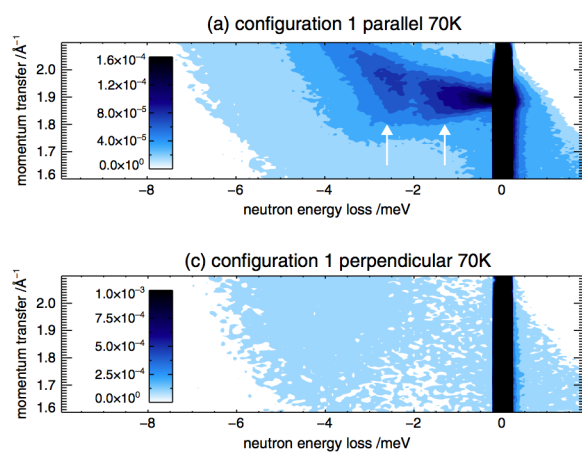

L. van Eijck *et al.*, PRL **107** (2011) 088102

Phonons in superfluid Helium

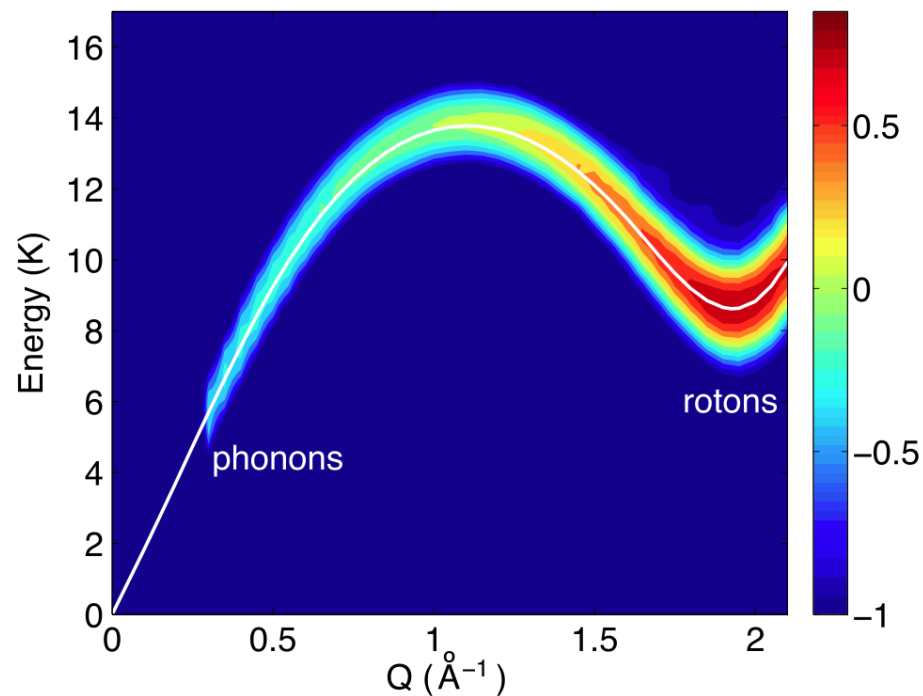

B. Fåk *et al.*, PRL **109** (2012) 155305

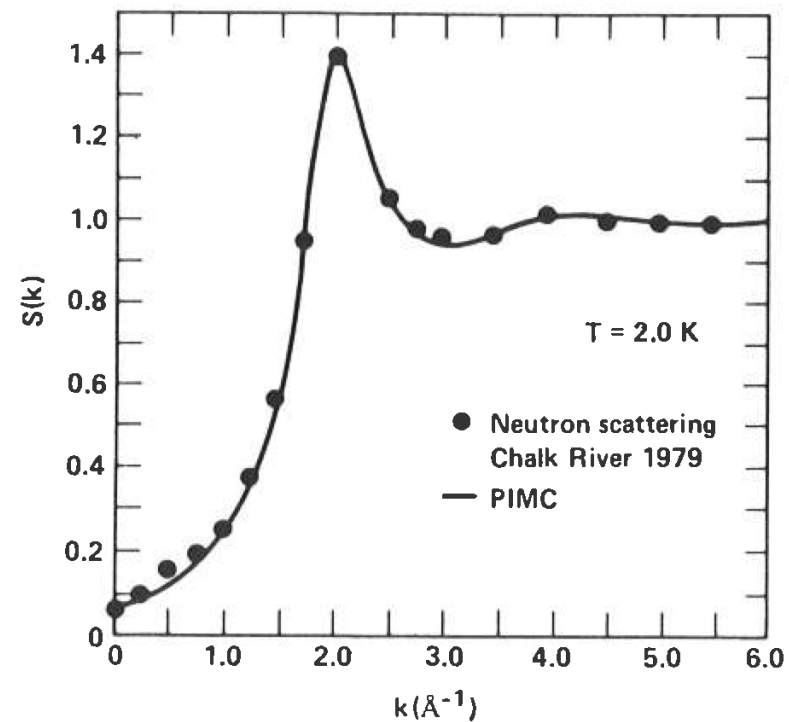

E. C. Svensson *et al.*, PRB **23** (1981) 4493

D. M. Ceperley and E. L. Pollock, Can. J. Phys. **65** (1987) 1416

H. R. Glyde, *Excitations in Liquid and Solid Helium*
(1994) Clarendon, Oxford

Spin waves and magnons

A simple Hamiltonian for spin waves is:

$$H = -J \sum_{i,j} \mathbf{s}_i \cdot \mathbf{s}_j$$

J is the magnetic exchange integral, which can be measured with neutrons.

Take a simple ferromagnet:

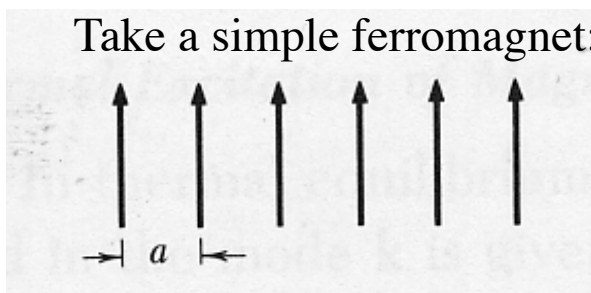

The spin waves might look like this:

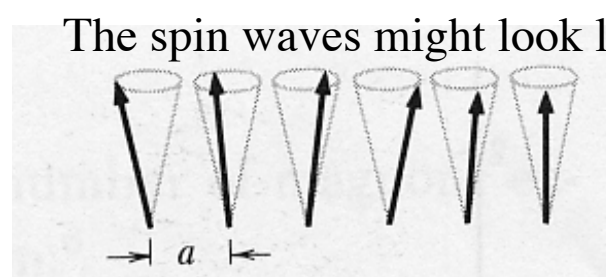

Spin waves have a frequency (ω) and a wavevector (\mathbf{q})

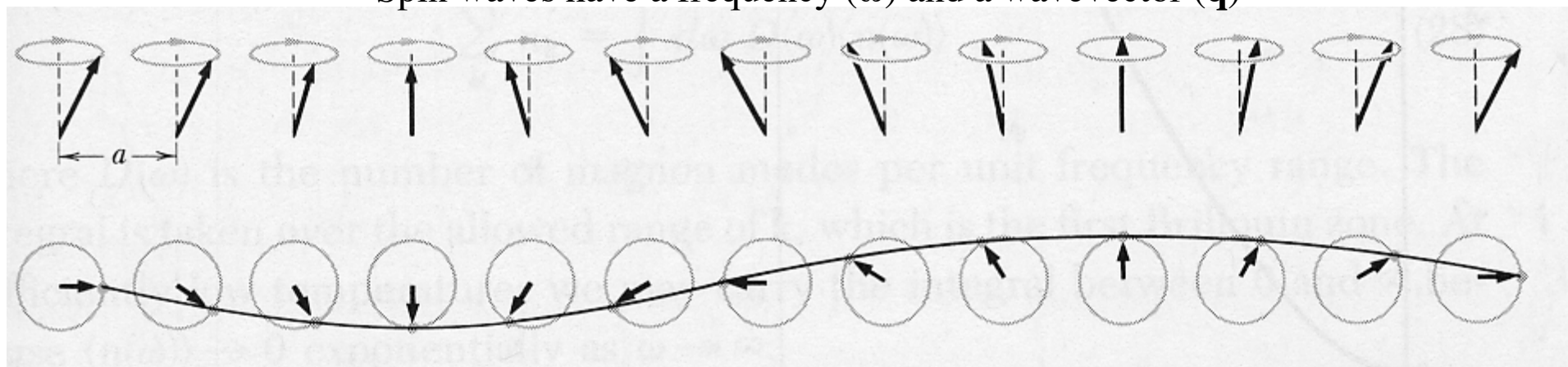

The frequency and wavevector of the waves are *directly measurable* with neutrons

Magnetic excitations in CuSO_4

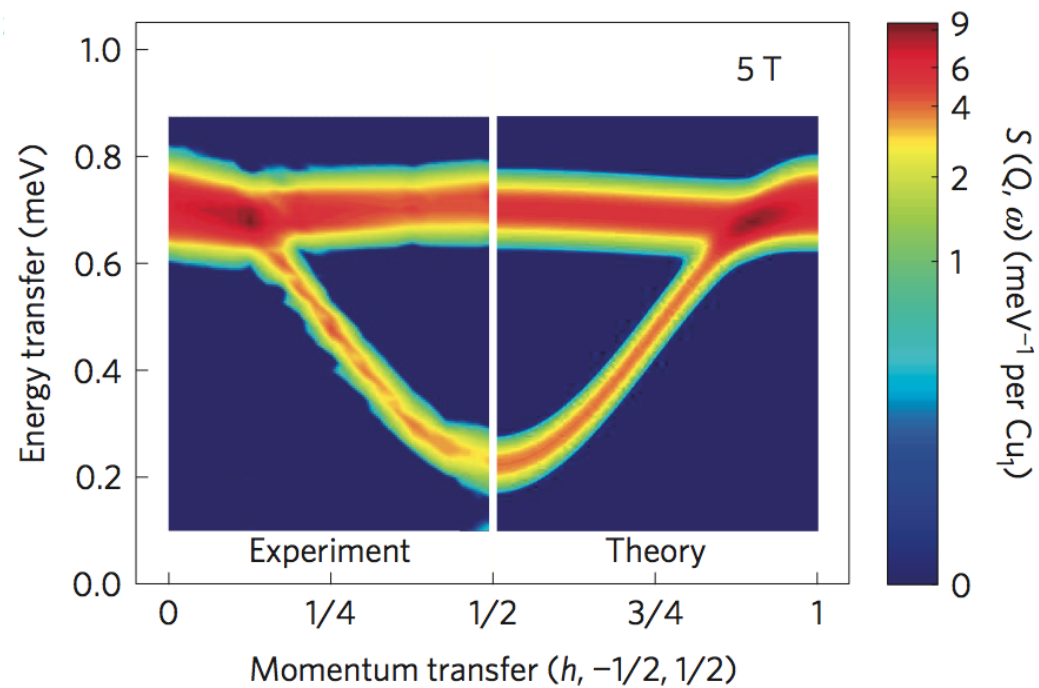
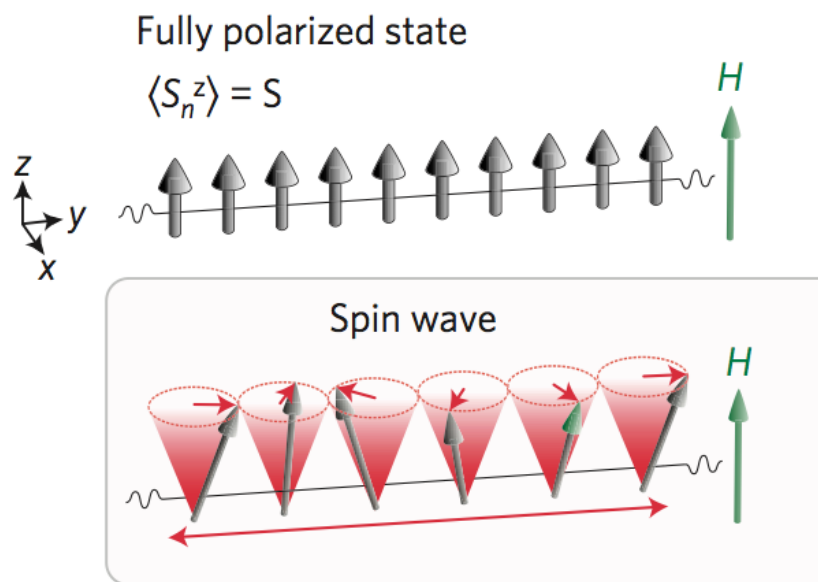
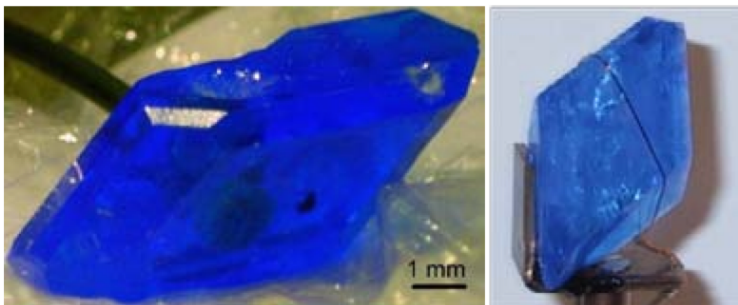

M. Mourigal *et al.*, Nature Phys. **9** (2013) 435

Spin-waves in Rb_2MnF_4

A quasi-two dimensional antiferromagnetic system

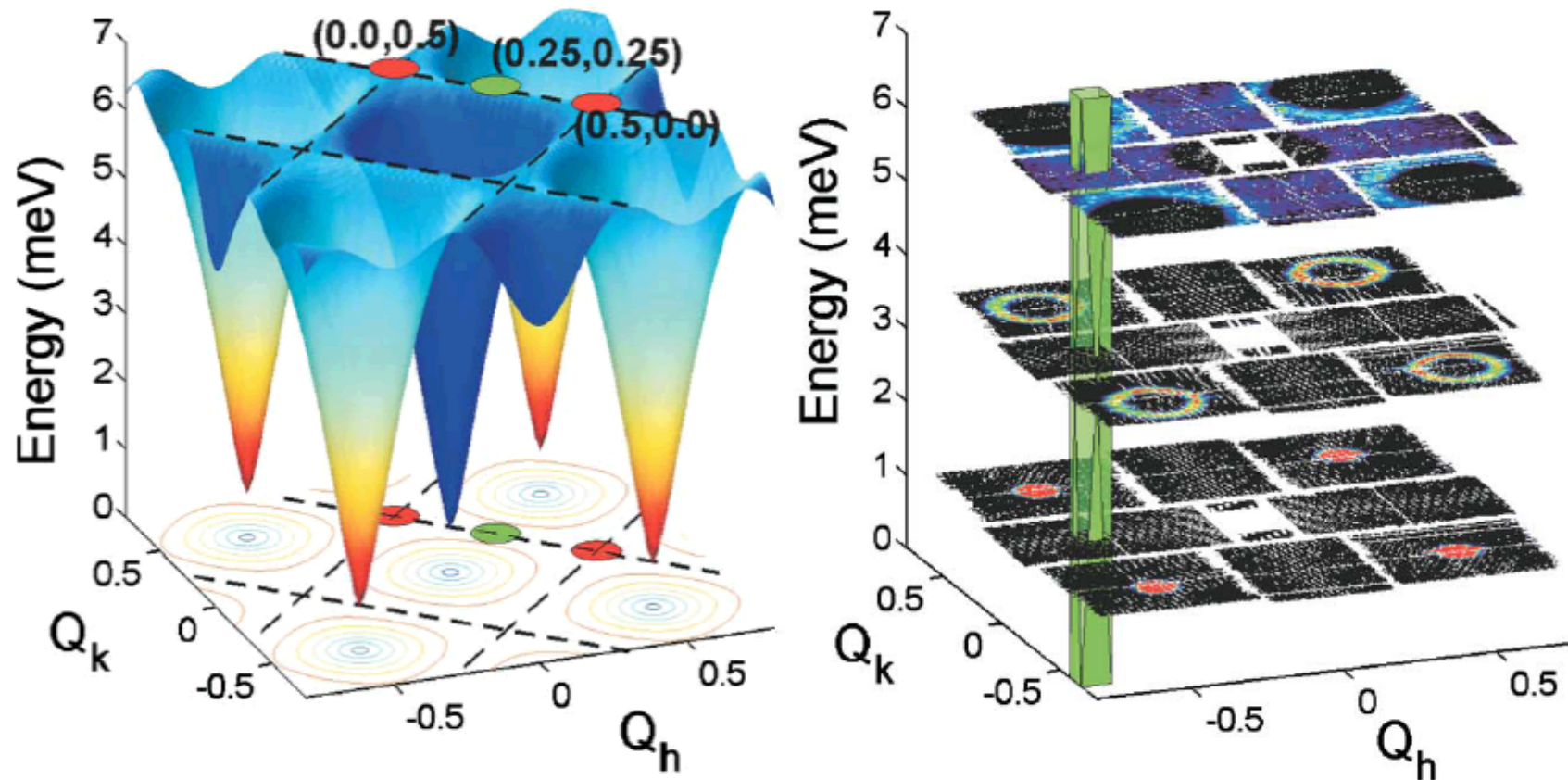

T. Huberman *et al.*, Phys. Rev. B 72 (2005) 014413

Spin-waves in $(\text{La,Ba})_2\text{CuO}_4$

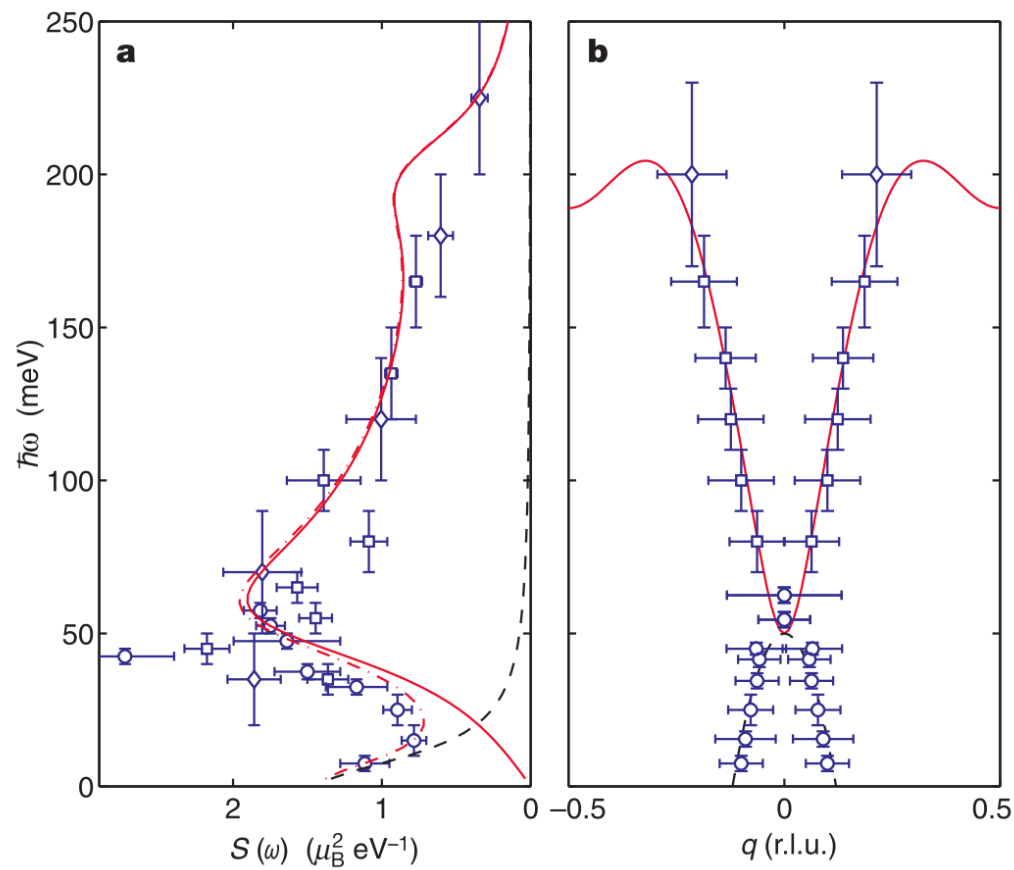
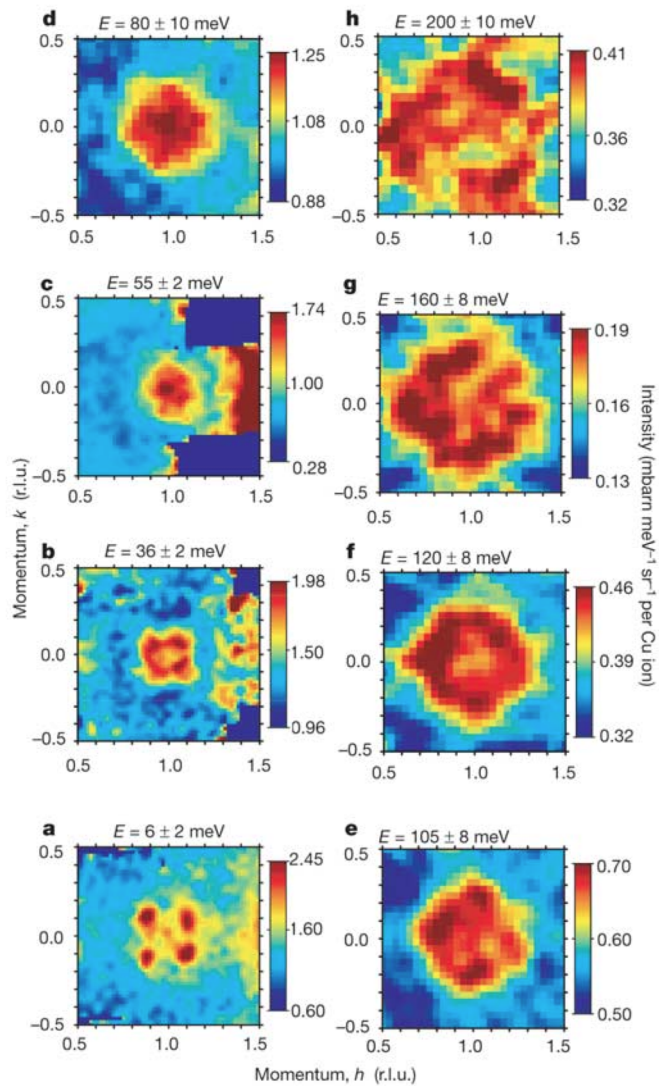

J. M. Tranquada *et al.*, Nature **429** (2004) 534

Spin-waves in MnPS_3

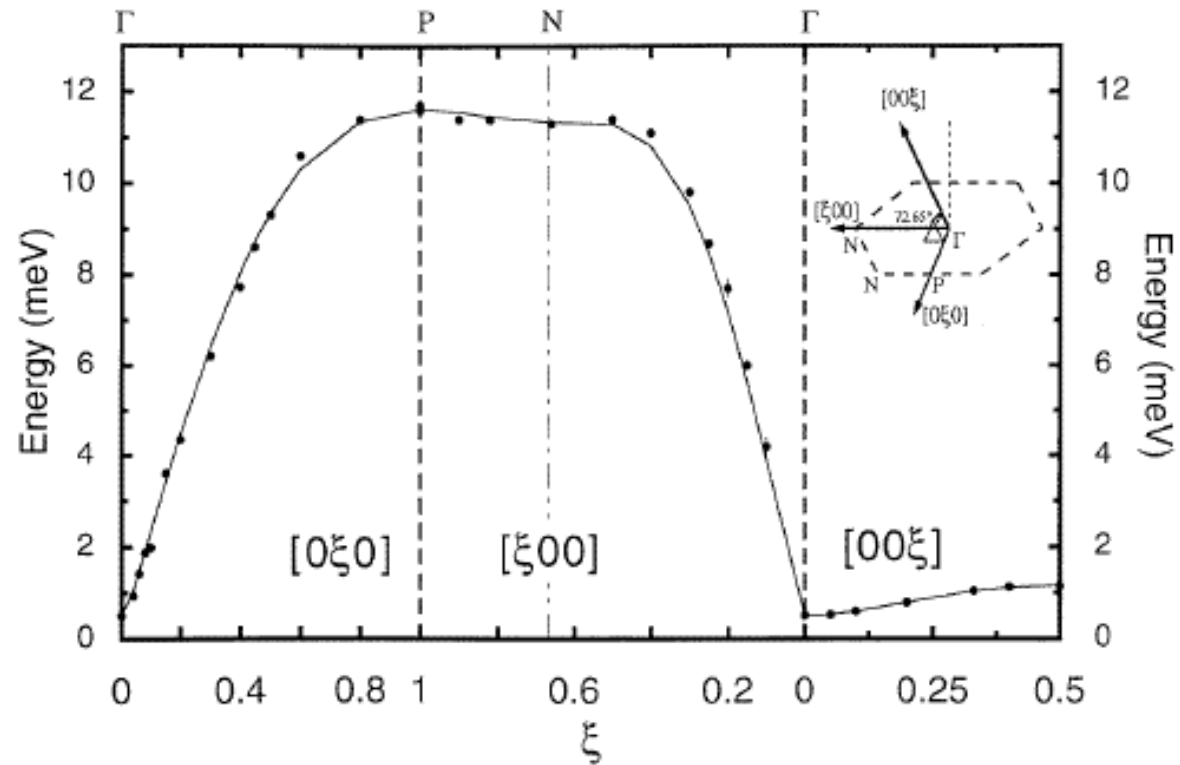

A. R. Wildes *et al.*, JPCM **10** (1998) 6417

Conclusions

Neutron spectroscopy is about measuring quantum oscillations
in solids and liquids

The neutron's momentum and energy are ideal for these