

X-ray phase imaging with grating interferometers

Timm Weitkamp, Ana Diaz, Christian David

Laboratory for Micro- and Nanotechnology, Paul Scherrer Institut, Villigen, Switzerland

Oliver Bunk, Amela Groso, Marco Stampanoni, Franz Pfeiffer
Swiss Light Source, Paul Scherrer Institut, Villigen, Switzerland

Peter Cloetens, Eric Ziegler
European Synchrotron Radiation Facility, Grenoble, France

See copyright notice and terms of use on next slide



Coherence 2005 Workshop, Porquerolles, 15 June 2005

Copyright notice and terms of use

The material in this file is copyrighted.

You may download and view the file from its web repository, but please

- do not redistribute this file or any part of it or its contents in any form,
- do not use any of the contents of this file in presentations or publications without prior written consent of the authors.

Thank you. Authors can be reached at the following addresses:

Timm Weitkamp, ESRF, 6 rue Jules Horowitz, 38043 Grenoble, France
E-mail timm.weitkamp@psi.ch, weitkamp@esrf.fr

Christian David, Paul Scherrer Institut, 5232 Villigen PSI, Switzerland
E-mail christian.david@psi.ch

11 July 2005

Motivation

- Hard X rays well suited for radiographic imaging (long penetration depth, negligible refraction)
- General setup uses **absorption contrast**:
Area detector behind sample records intensity variations caused by attenuation profile of the sample
- **Tomography**: taking 2D radiographs at different viewing angles yields 3D distribution $\mu(x,y,z)$
- But for **light materials** (biological tissue, polymers...), and **high photon energies, absorption contrast is relatively weak**
- Better image contrast would result in
 - **Shorter exposure times** (materials science applications)
 - **Reduced dose deposition** (biology, medical imaging)

Phase radiography methods

Crystal interferometers
Bonse & Hart 1965

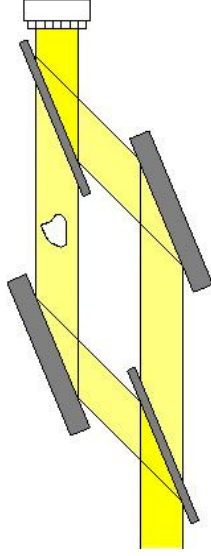

Analyzer-crystal based
("diffraction-enhanced
imaging", DEI)
Ingal & Beliaevskaya 1995

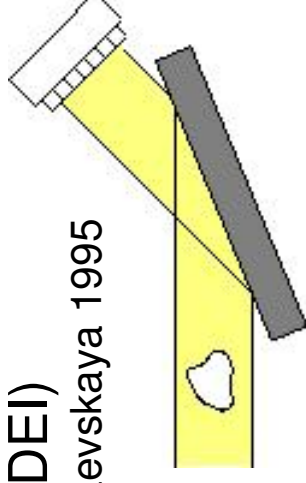

Free-space propagation
("Inline phase contrast")

Snigirev 1995, Wilkins 1995, Cloetens 1996

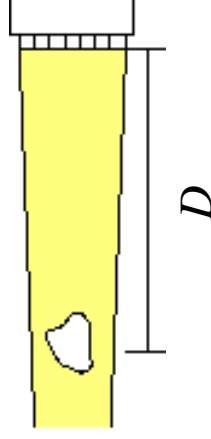

→ Lots of different schemes already

Why yet another method?

- For the combination of...
 - large field of view (moderate resolution),
 - possibility of use with an X-ray tube source,
- ... the existing methods have problems:
 - Bense-Hart: crystal size limits FOV
 - DEI: monochromaticity, collimation → needs SR
 - FSP: excellent for high resolution, but at moderate resolution, large distances required
- Grating interferometer: may fill this domain

Grating interferometry

- Phase grating as a beam splitter
- Wavelength $\approx 1 \text{ \AA}$, grating period $\approx 1 \text{ \mu m}$
 - small diffraction angles
 - beams overlap

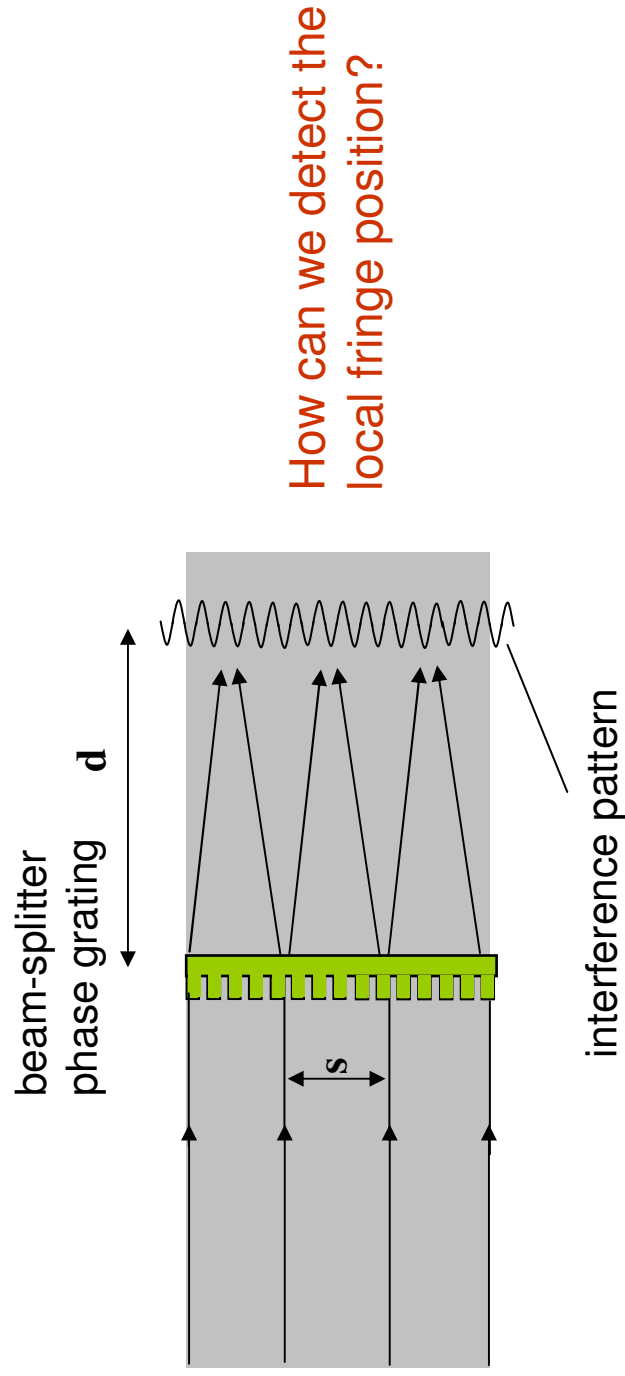

Grating interferometry

- Absorption grating with same period as fringes
- Acts as transmission mask (not as diffractive element!)
- Transforms fringe positions into intensity signal
 - May use detector with pixels larger than fringe width

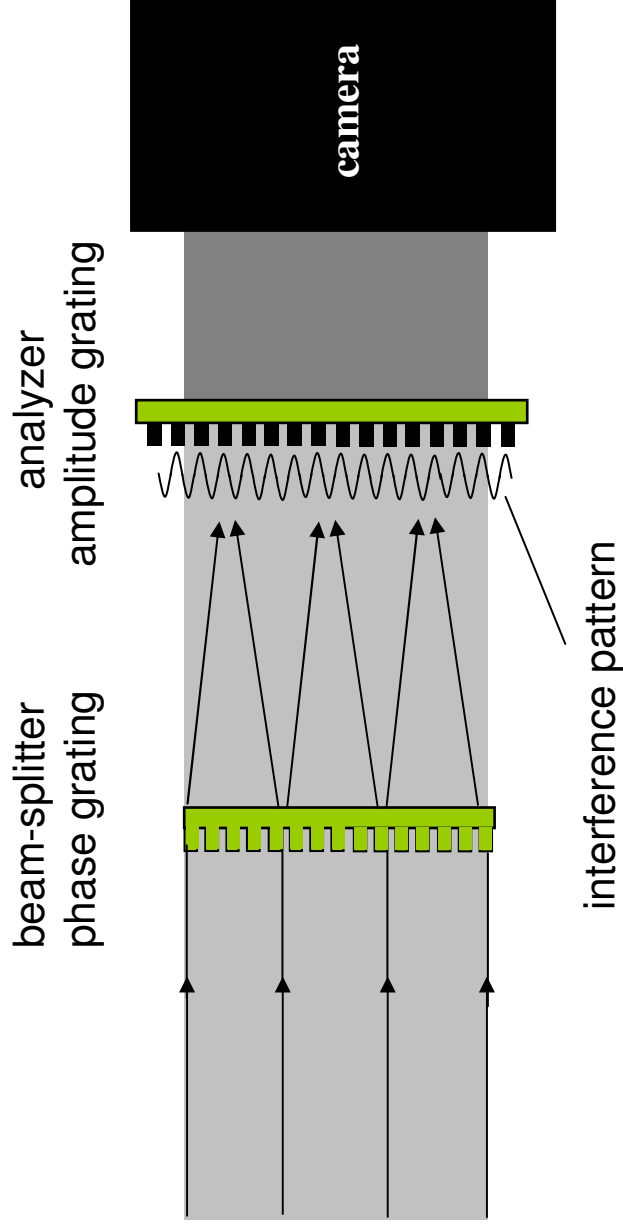

Grating interferometry

- Object in beam
- Distorts wavefront, i.e., deflects beam
- Fringes locally displaced
- Different intensity on detector
- Intensity correlated to first derivative of wavefront phase

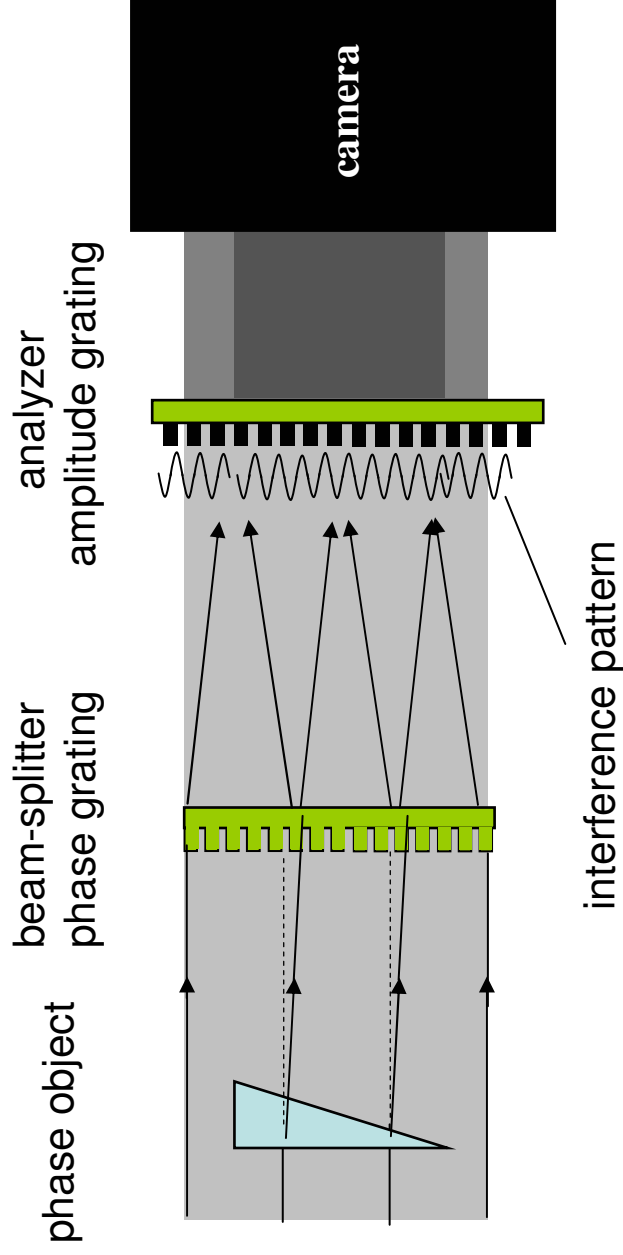

→ Differential phase contrast imaging

But how to separate phase information from absorption?

Phase-stepping interferometry

Linear transverse scan
of one of the gratings:
→ signal oscillates

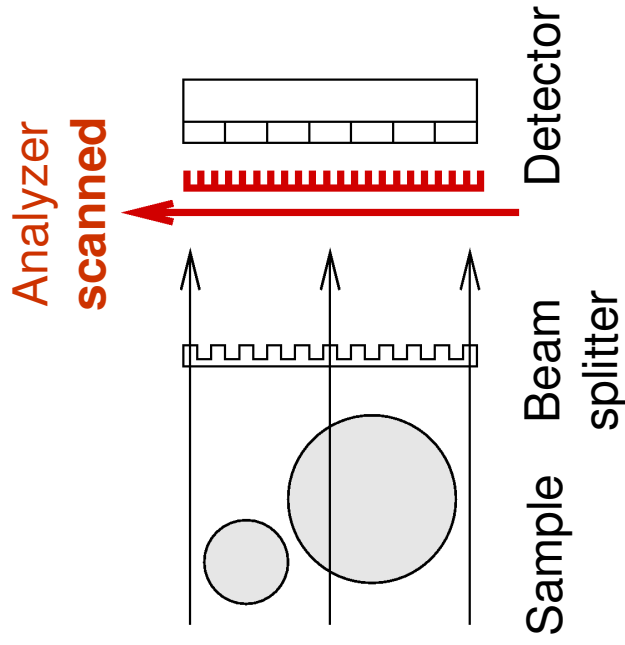

(sample here:
polystyrene spheres
Ø 100 and 200 μm)

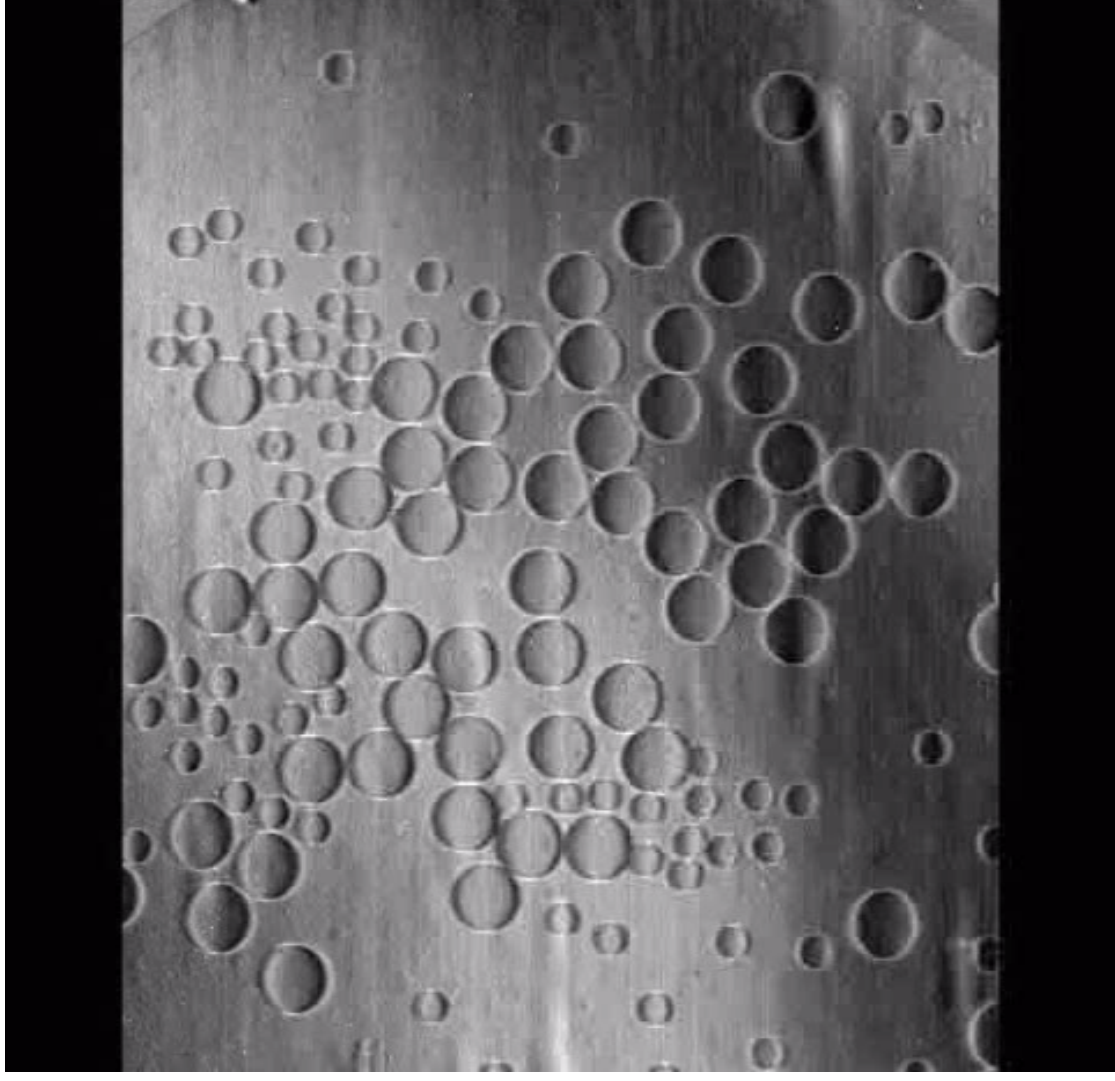

ESRF BM5, $E=12.4$ keV, $p_1=4$ μm , $p_2=2.004$ μm

Phase-stepping interferometry

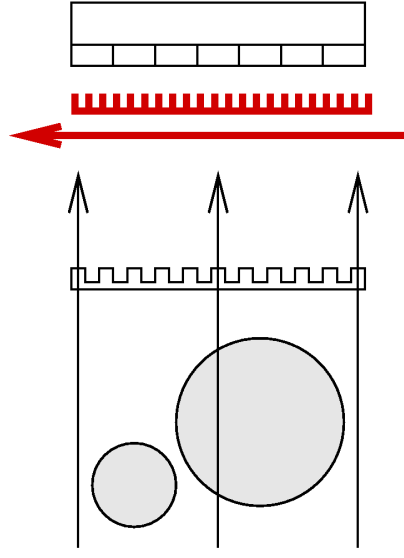
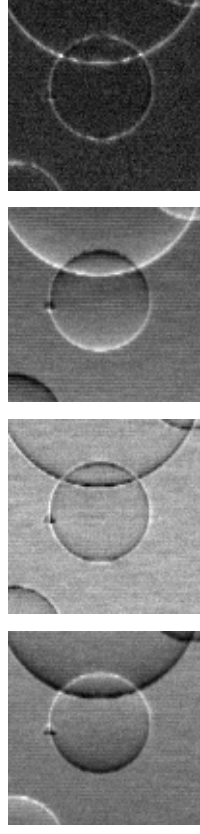

Phase-stepping interferometry

Consider individual
pixels:
Intensity oscillates

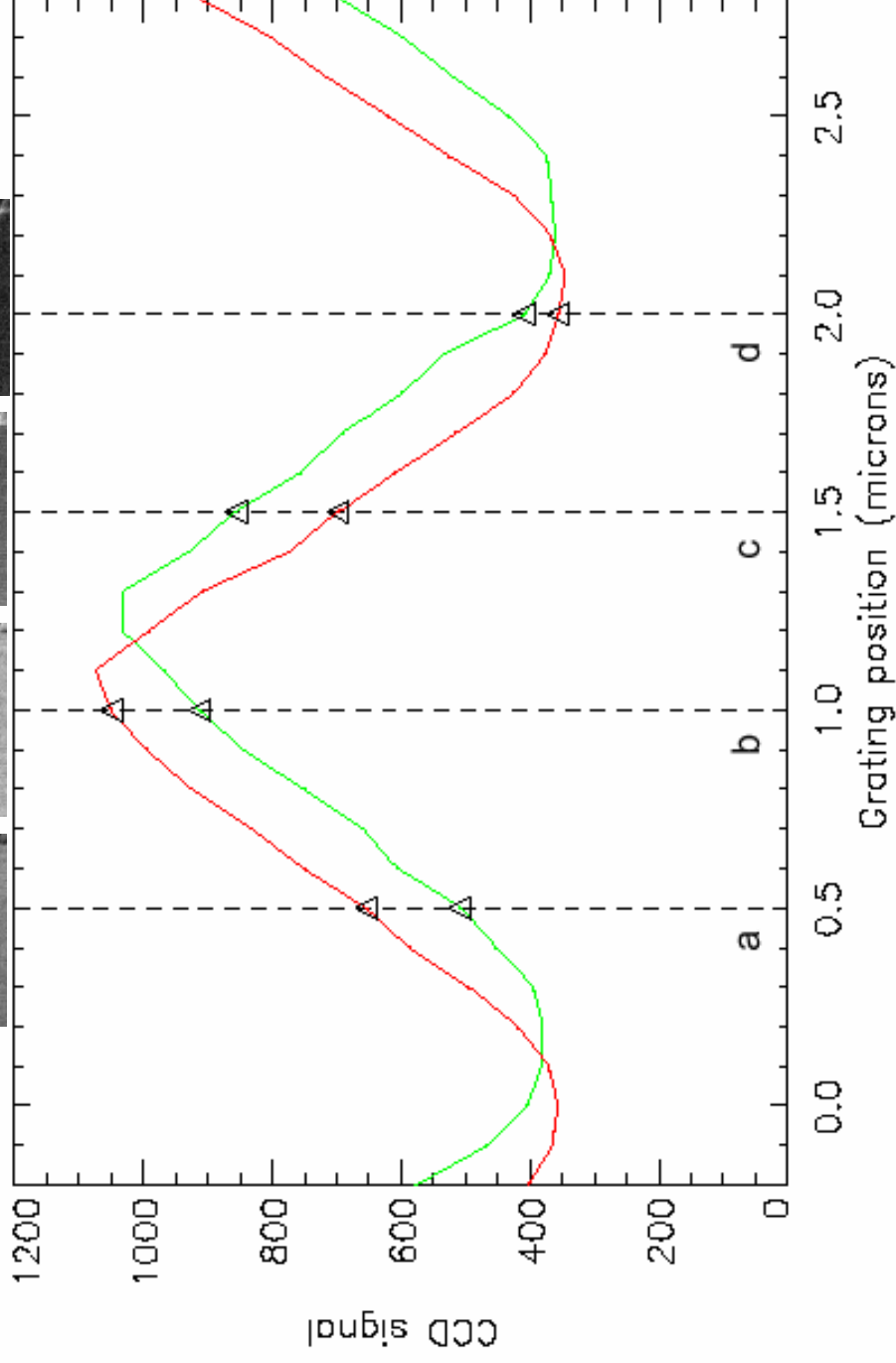
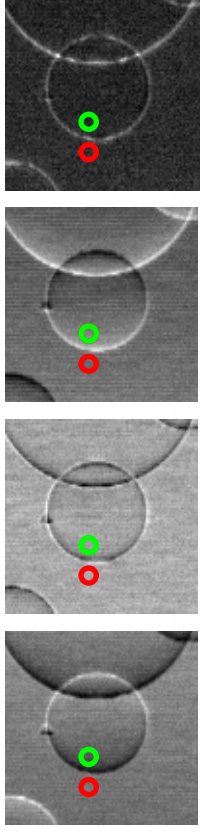

Phase-stepping interferometry

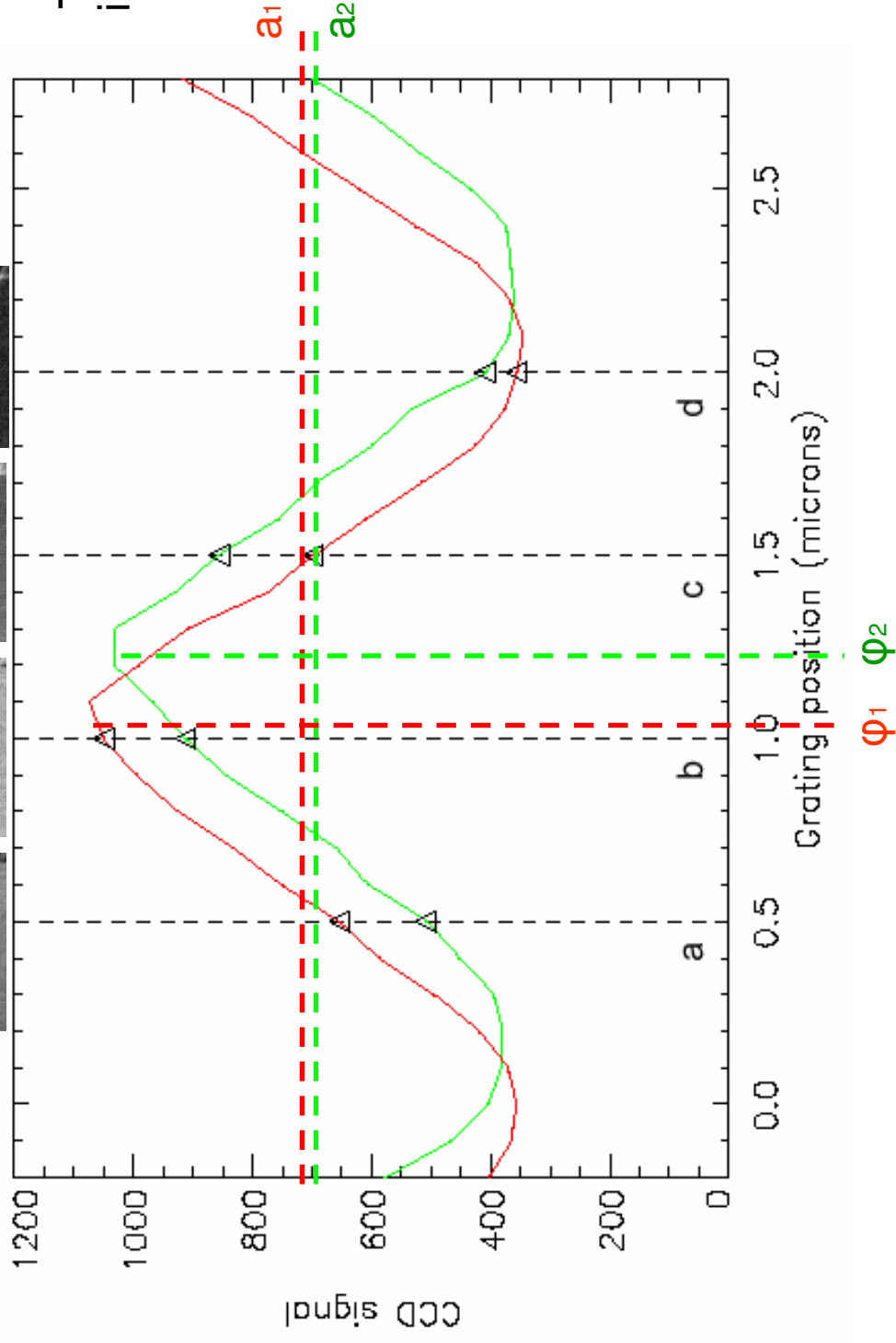
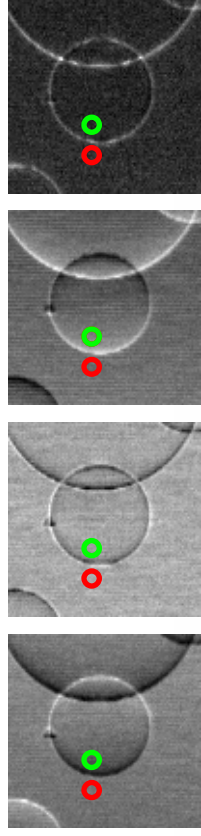

Phase-stepping interferometry

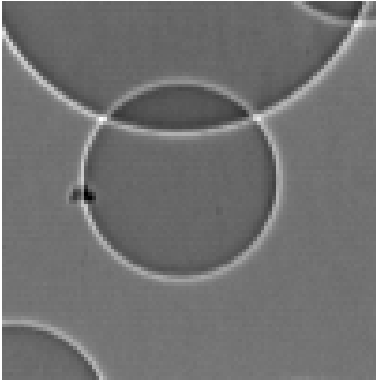

a_{ij} Mixture of absorption and inline phase contrast

--- **the same image that would be observed without the interferometer in the beam**

(suited for tomographic reconstruction)

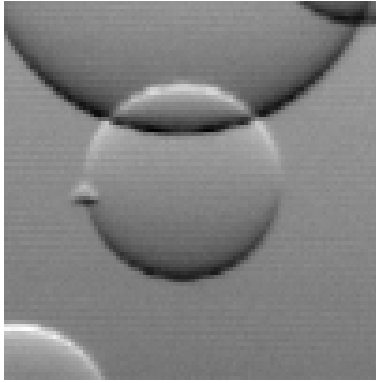

φ_{ij} **Phase gradient image** (perpendicular to grating lines)

--- all absorption contributions eliminated

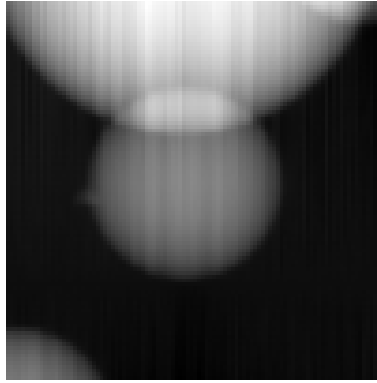

Can be integrated to yield projected phase shift of sample

→ Suited for tomographic reconstruction

→ Quantitative: $\frac{\partial \Phi(x, y)}{\partial x} = \frac{P_2}{\lambda d} \varphi(x, y)$

Phase-stepping tomography

Slow axis:
tomo rotation

Fast axis:
phase stepping

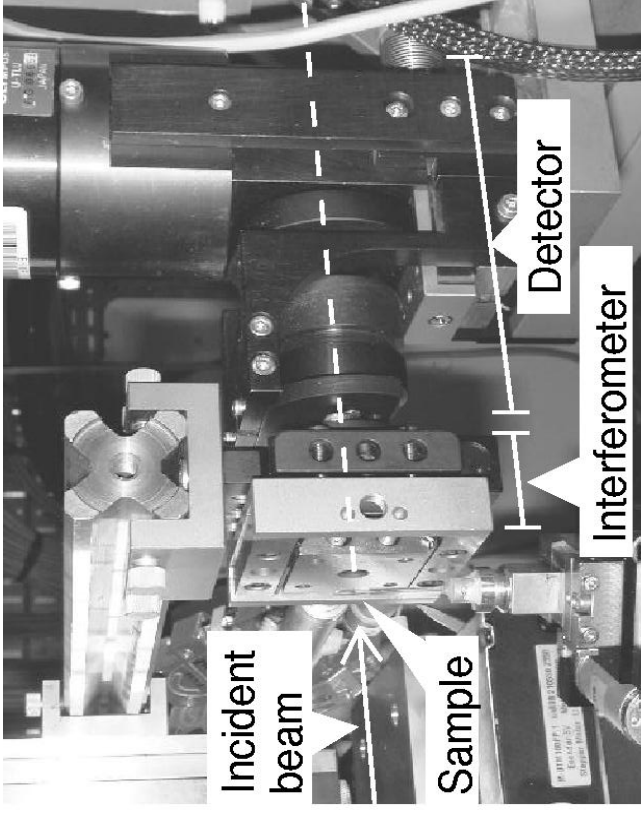
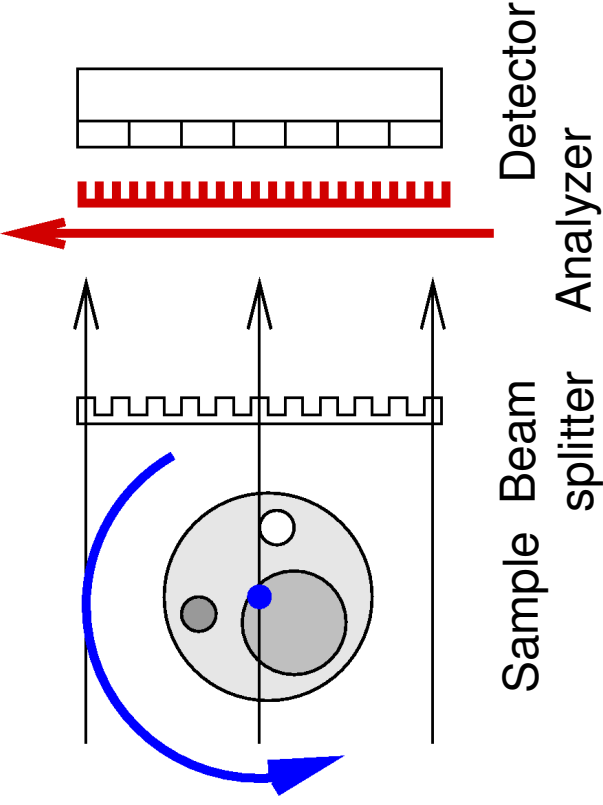

ESRF ID 19, June 2004

$E=12.4$ keV, $p_1=4$ μm , $p_2=2$ μm , $d=23$ mm

- Two scan axes: projection angle and interferometer phase
- Number of projection angles: 100...1000
- Number of phase-stepping points per angle: 4 or more
- Results: 3D distributions $\delta(x,y,z)$ and $\mu(x,y,z)$

Beam splitter phase grating ($p = 4 \mu\text{m}$) and analyzer absorption grating ($p = 2 \mu\text{m}$)

Phase grating (Si)

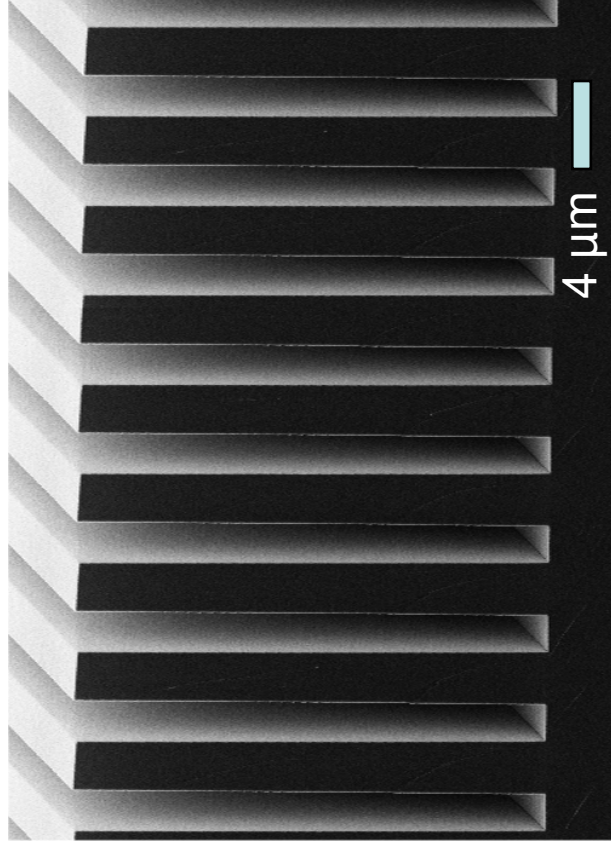

Absorption grating (Au in Si)

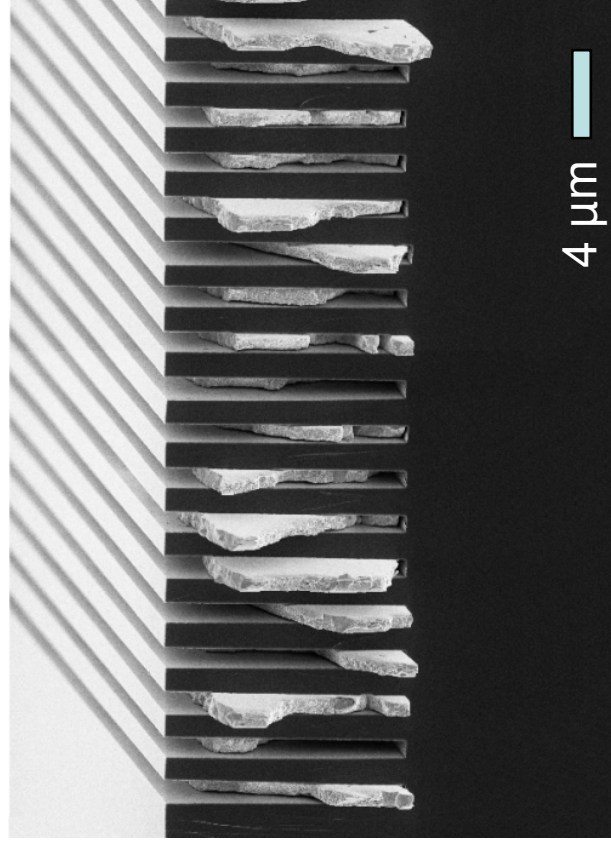

- Silicon wet-etched
- Depth of structures chosen so that phase shift is $\pi \rightarrow$ no zero order
- \rightarrow **Efficiency limit: 80 %**
(fraction of useful photons)

- Gold in gaps of silicon grating
- Grown electrochemically
- Period is half that of Si grating
- **Efficiency limit: 50 %**
(fraction of transmitted intensity)

\rightarrow **Poster P9, A. Diaz et al.**

0.5 mm



Tomography of a spider:
Isosurface rendering of X-ray refractive index

0.5 mm

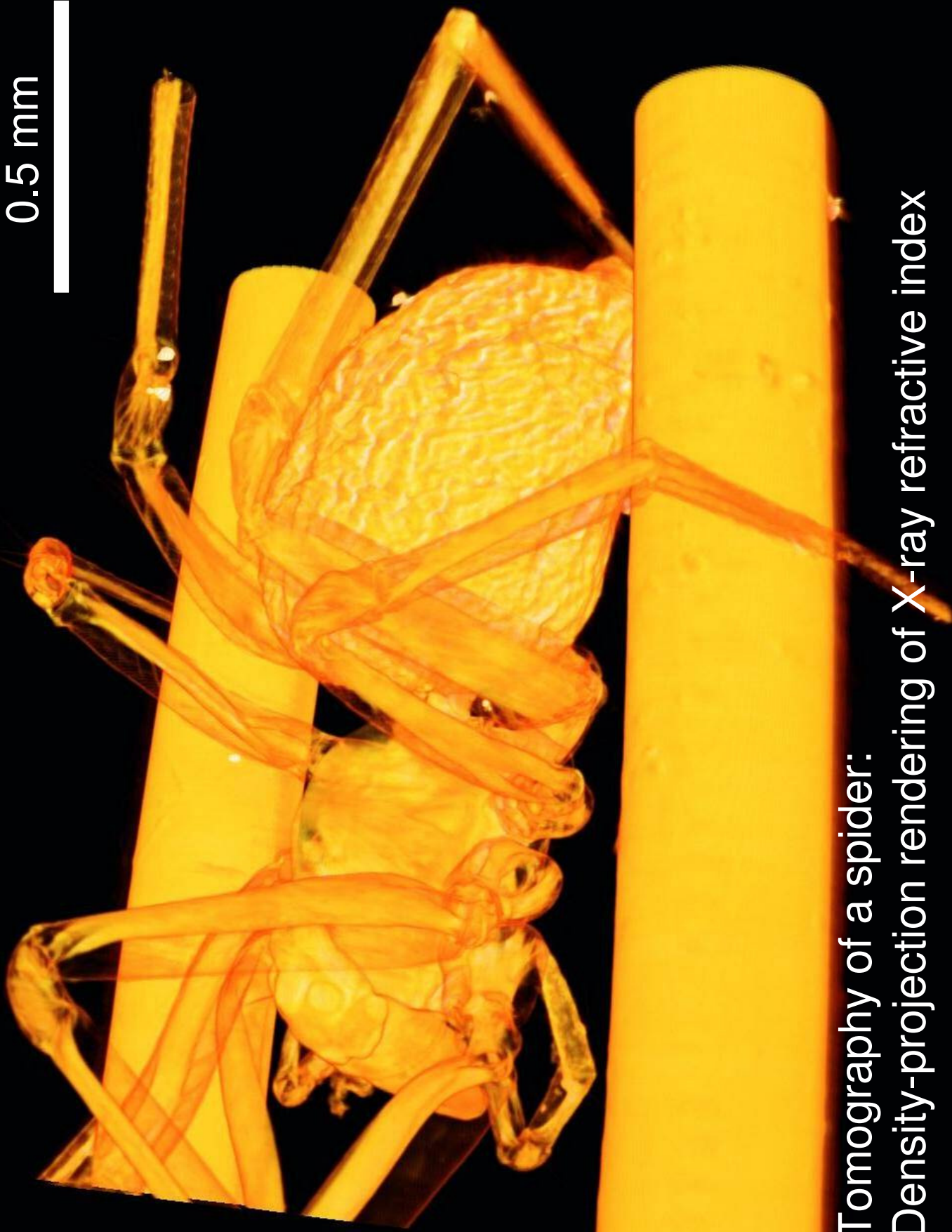

Tomography of a spider:
Density-projection rendering of X-ray refractive index

Non-interferometric projection

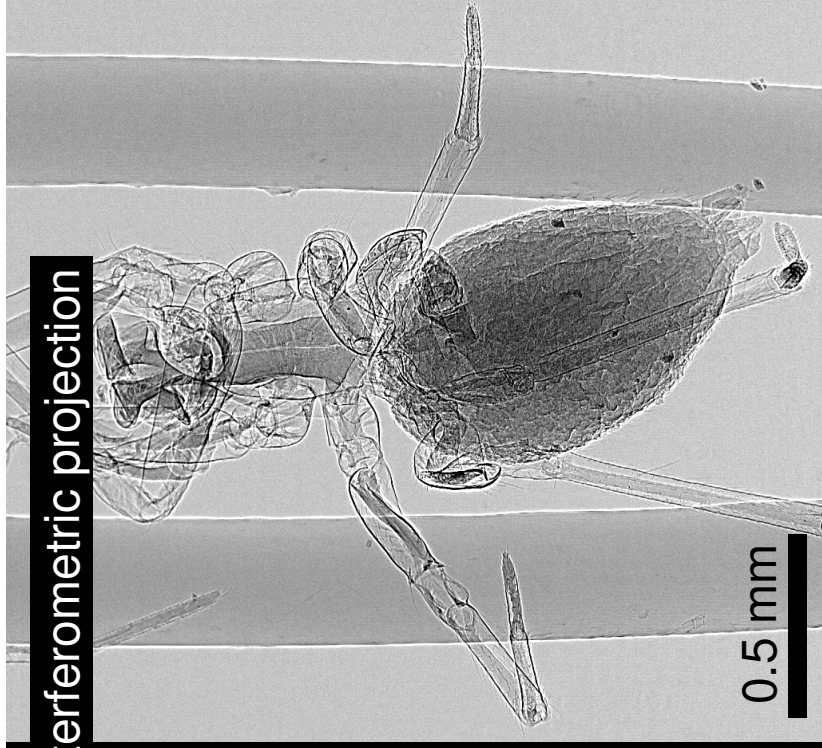

Interferometric phase projection



Non-interferometric tomogram

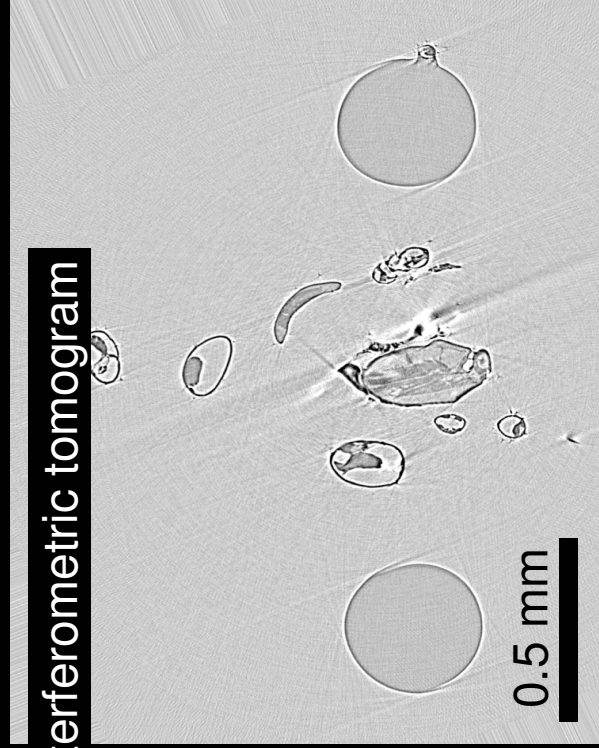

Interferometric phase tomogram

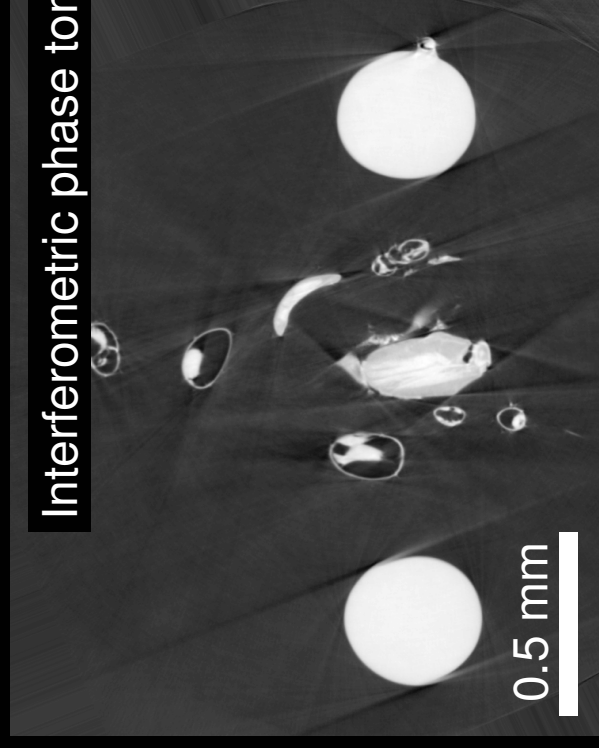

Quantitative phase reconstruction I

Example: phase profile of parabolic refractive lenses

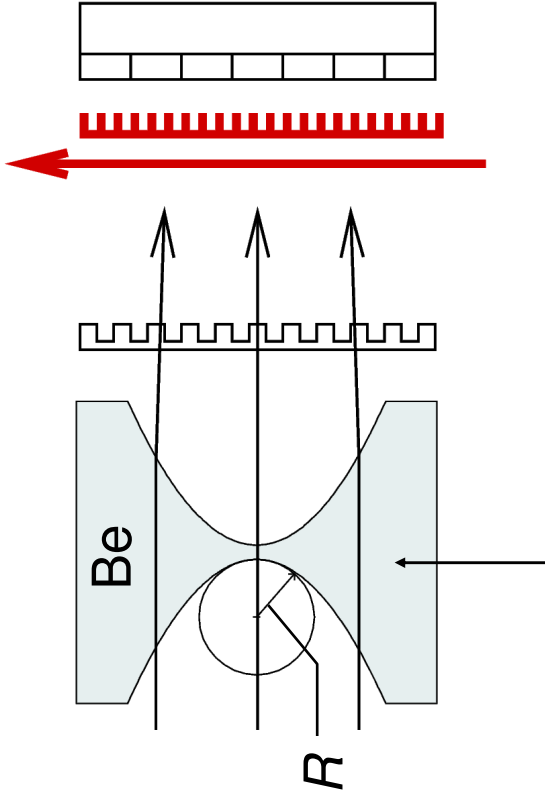

Beryllium refractive lens,
 $R=0.2$ mm
 $\rightarrow f=61$ m at 14.4 keV

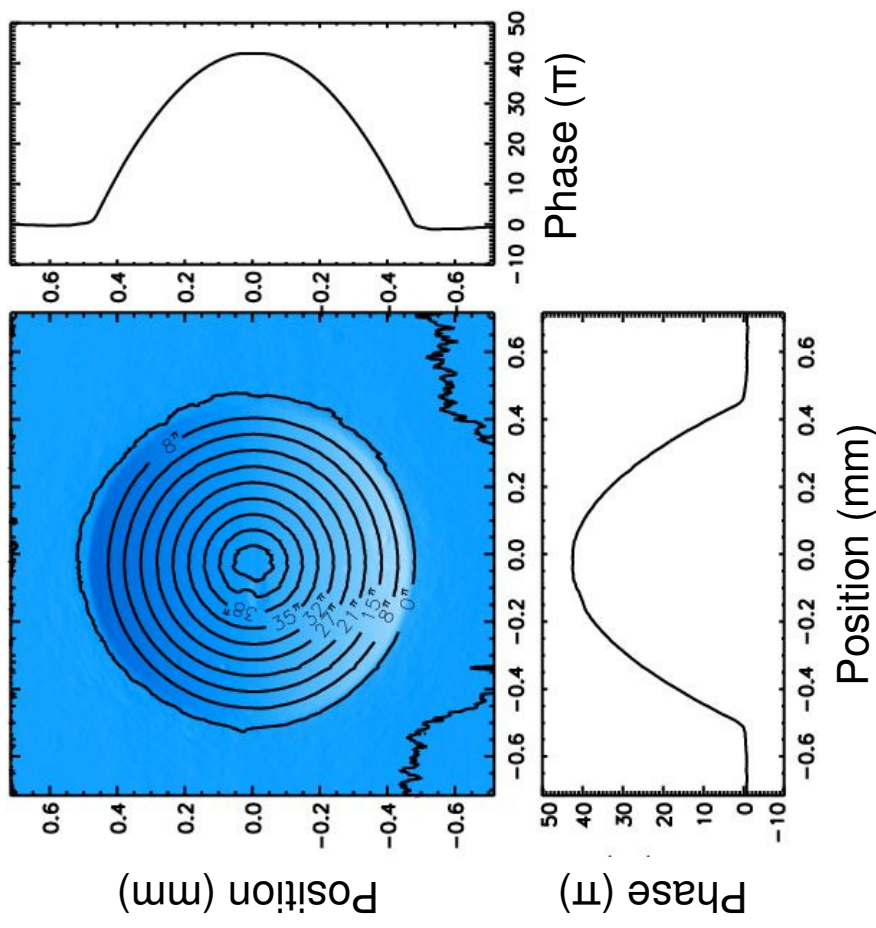

ESRF BM5, 9 June 2005
 Collaboration with J. Patommel, B. Lengeler (RWTH), C. Schroer (HASYLAB)

Quantitative phase reconstruction I

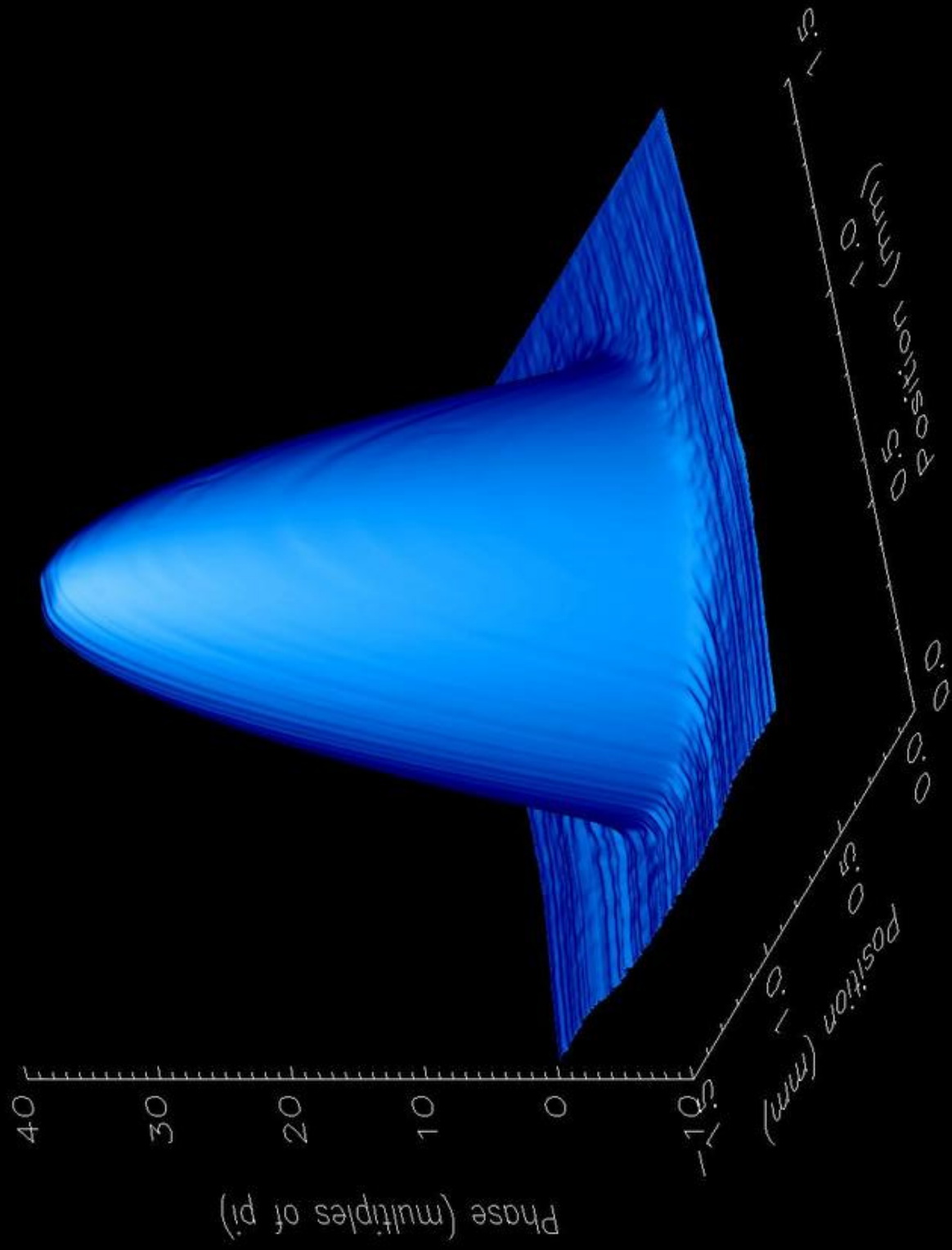

Quantitative phase reconstruction II: pink-beam tomography

Non-interferometric
tomogram

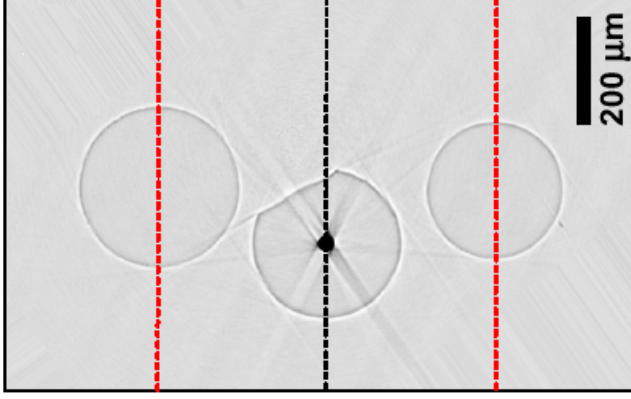

Interferometric
phase tomogram

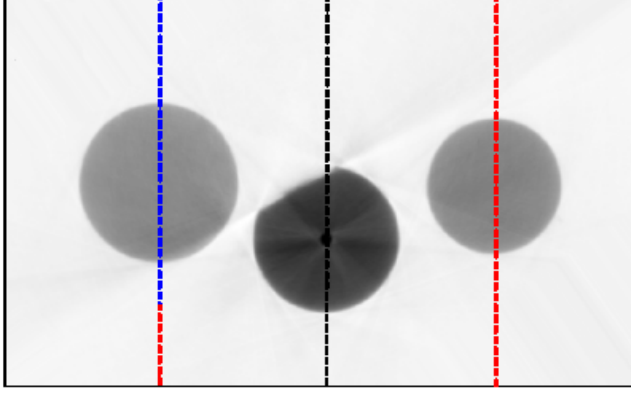

Sample:

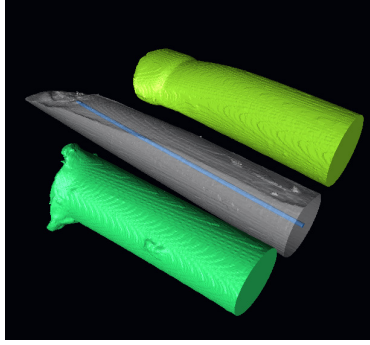

$E = 17.5 \text{ keV}$,
 $\Delta E = 1 \text{ keV}$

Three fibers

- Polyamide $\text{\O} 225 \text{ }\mu\text{m}$
- Boron $\text{\O} 200 \text{ }\mu\text{m}$, core: $W \text{\O} 10 \text{ }\mu\text{m}$
- PBT $\text{\O} 190 \text{ }\mu\text{m}$

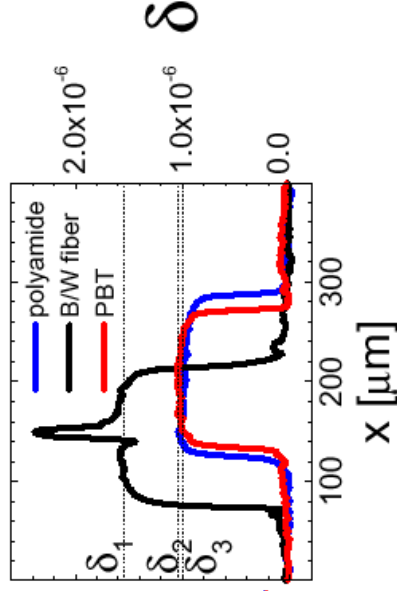

SLS Materials Science beamline

July 2004

Polychromatic radiation

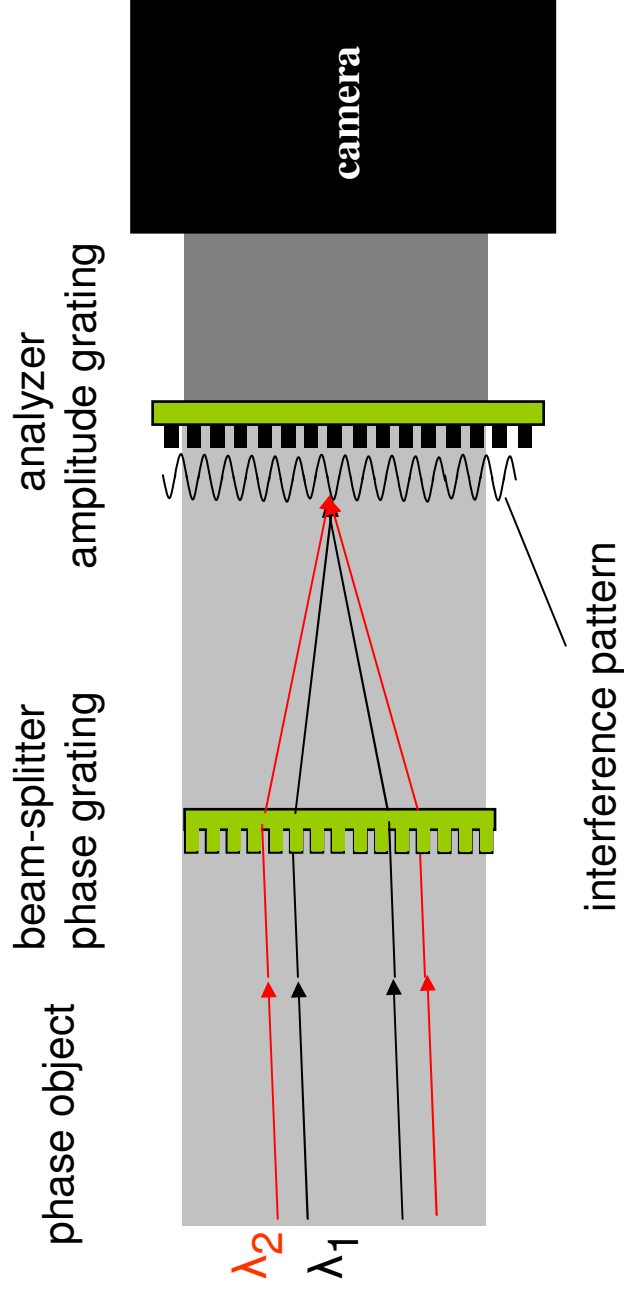

→ Quasi-achromatic instrument

Limits of achromaticity

Effects of energy change (away from design energy) on efficiency of a given setup:

- Inter-grating distance: deviates from Talbot condition,
- Beam splitter: phase shift deviates from π ,
- Analyzer: changes absorption.

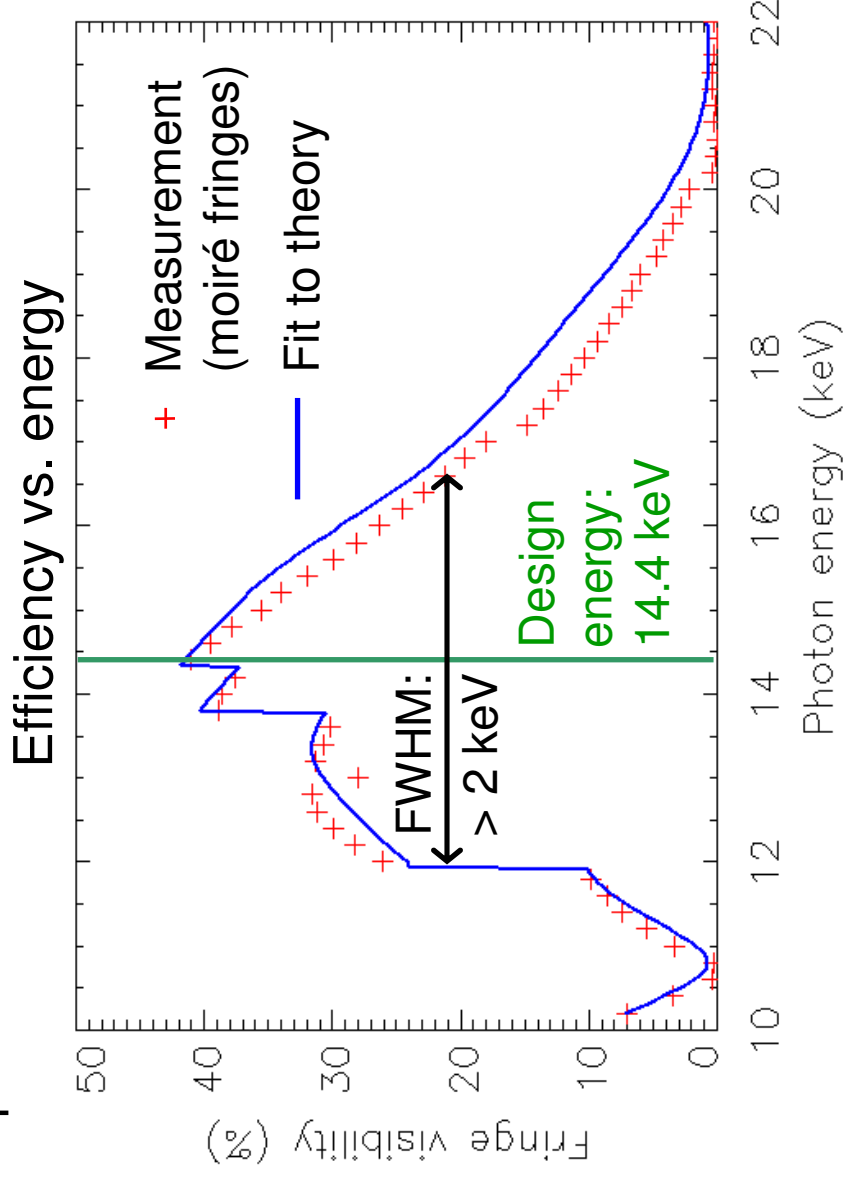

(Grating periods $p_1=4 \mu\text{m}$, $p_2=2 \text{ m}$, $p_3=2 \text{ m}$, 3rd Talbot distance $d_3=69.7 \text{ mm}$)
Data taken at ESRF BM5, 11 June 2005

Biological tissue samples in aqueous environment

- Conditions similar to natural environment, i.e., to *in-vivo* imaging
- Contrast between tissue and water is very weak, i.e., a real challenge
- Large object, moderate resolution enough → test case
- Our first sample: the heart of a rat, in formalin

Rat heart in formalin

- Walls of vessels clearly visible in the phase-contrast image
- ... but not in the absorption image acquired with the same dose

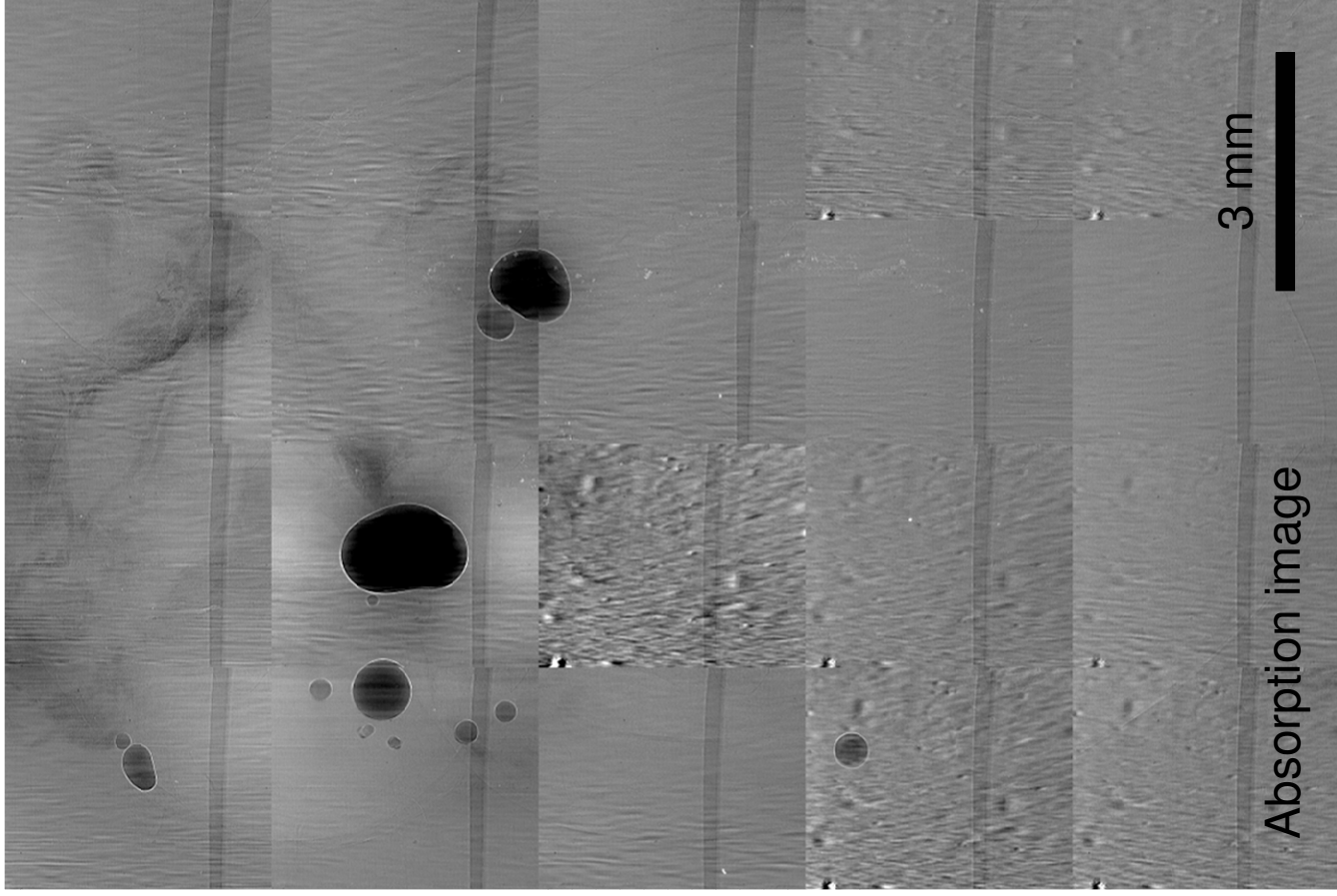

Pixel size 14 μm

Image stitched from 5x4 detector frames
SLS beamline 4S, 29 Jan 2005

Sample by T. Khan, Univ. hospital Zürich

Rat heart in formalin

- Walls of vessels clearly visible in the phase-contrast image
- ... but not in the **absorption image** acquired **with the same dose**
- Field of view here only limited by **synchrotron beam size**
--- not by the interferometer

Pixel size 14 μm
Image stitched from 5x4 detector frames
SLS beamline 4S, 29 Jan 2005

Sample by T. Khan, Univ. hospital Zürich

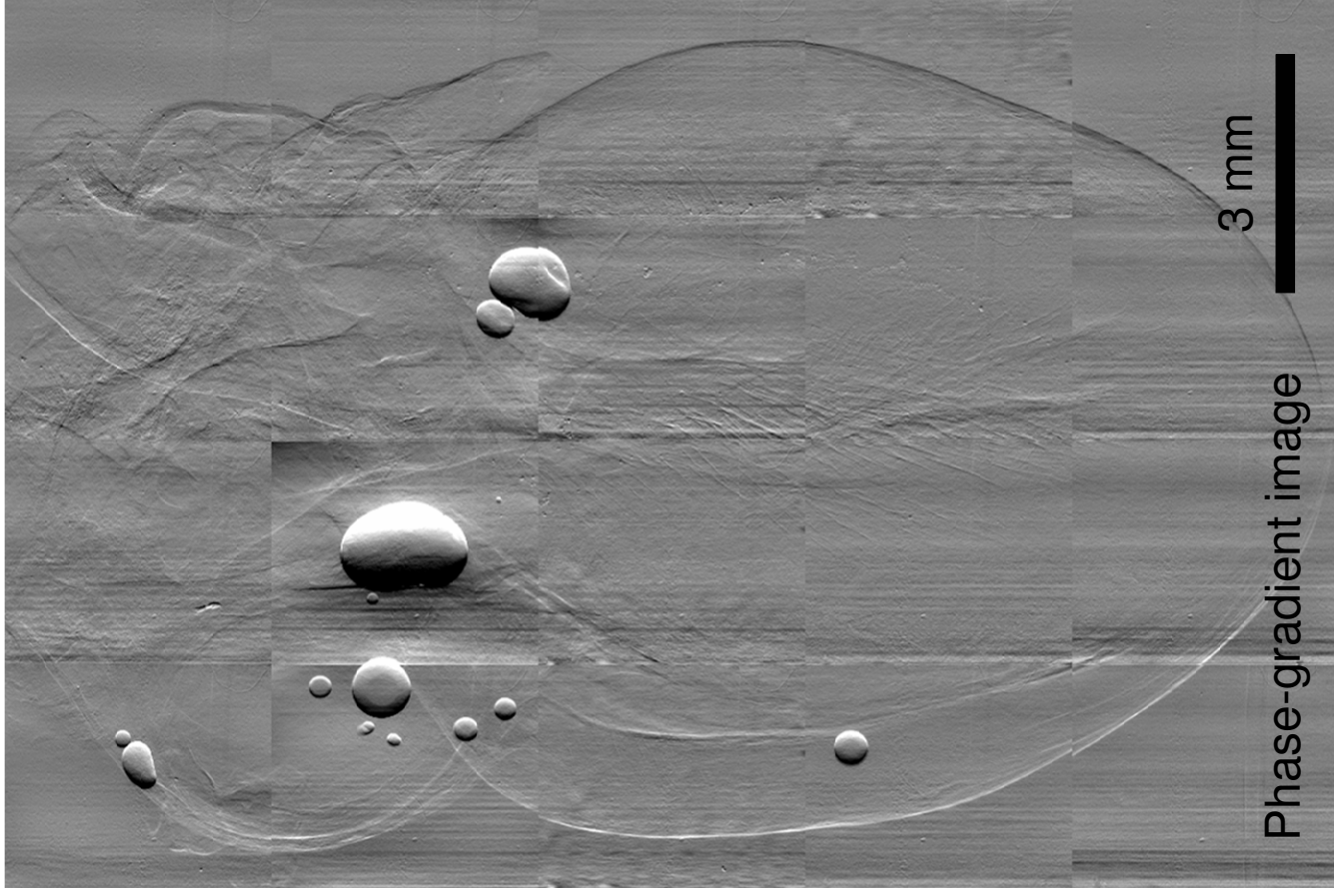

X-ray tube?

- Problem: **coherent flux**
- Have to use microfocus source
or slit a usual source down
- No better solution?
(i.e., higher flux) – we don't need the high
resolution of a micro focus
- Maybe using ... another grating?

Arrayed source

Trade resolution for flux, keeping coherence

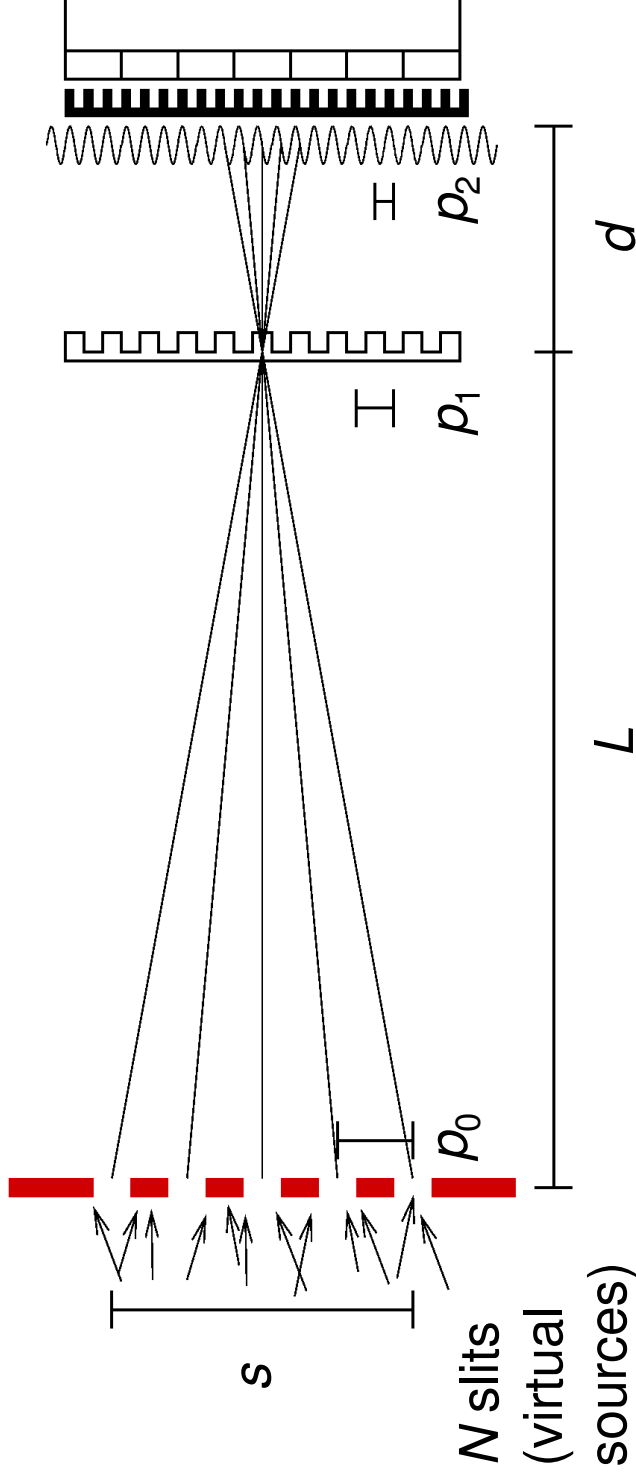

- Fringe patterns from the different virtual sources superimpose incoherently, but constructively.
- Spatial resolution degrades to $(s d / L)$.
- But flux is increased by a factor of N .

X-ray tube results

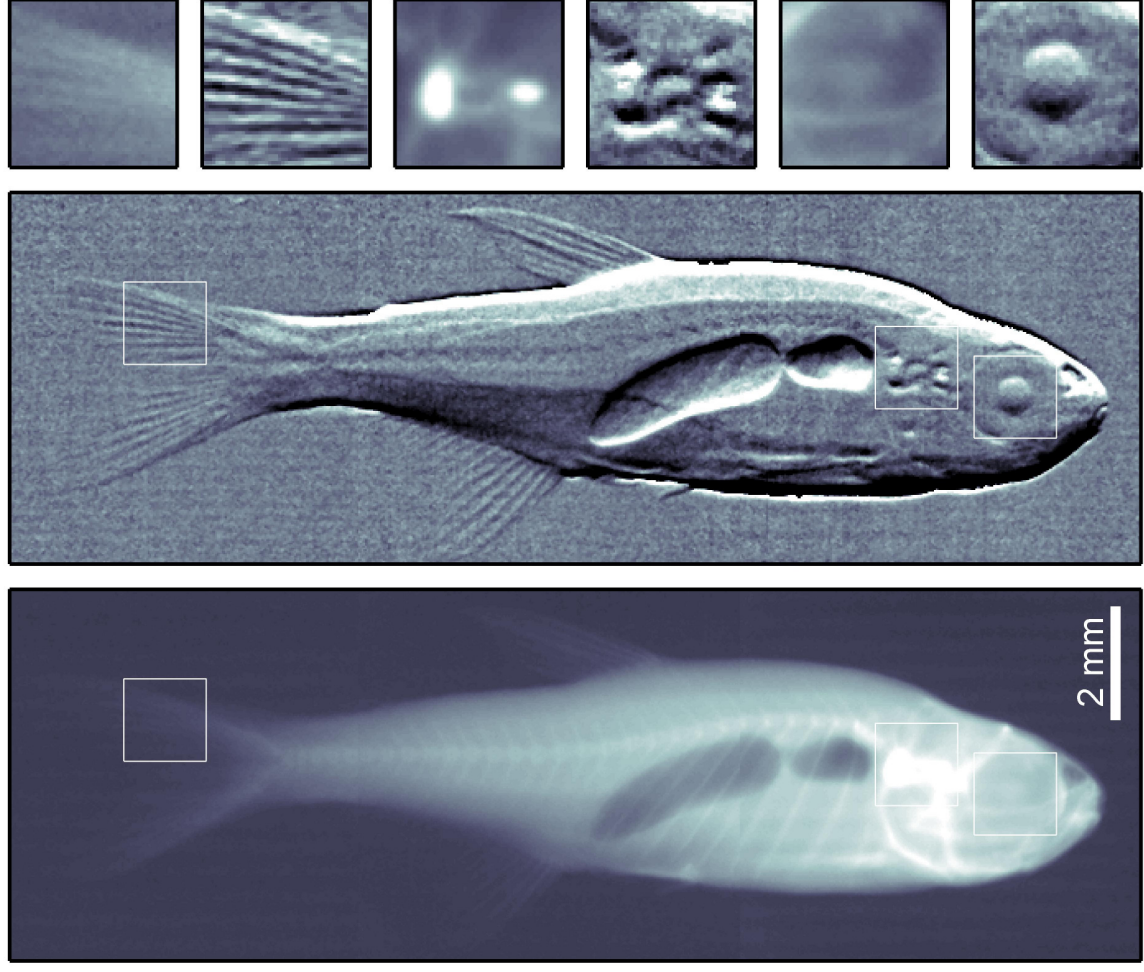

Summary

- Grating interferometer gives differential phase contrast ($d\Phi/dx$)
 - Phase stepping separates absorption from phase, yielding both phase Φ and transmission signal
 - Phase-stepping tomography yields refractive index $\delta(x,y,z)$
 - Results are quantitative
 - Instrument is largely achromatic
 - Stable, robust, almost no alignment
 - Better contrast than in absorption imaging with the same dose
 - With an arrayed source, efficient use with X-ray tube
 - Can be scaled up to higher energies and larger fields of view
- Suitable for radiography and tomography applications with large fields of view, moderate resolution

Posters:

- Wavefront sensing with moiré interferometry (P8, Christian David et al.)
- Fabrication of gratings (P9, Ana Diaz et al.)
- Coherence characterization (P44, Franz Pfeiffer et al.)